



# Low carbon stations for low carbon cities

Anne Leemans  
João Cruz  
Glenn Frommer  
Milena Ivkovic

**Yc**esignfoundation

MISTRA  
**URBAN  
FUTURES**

September 2015







A photograph of a red wall with a white window frame on the left side. The window frame is partially visible, showing a dark interior. The red wall has a slightly textured appearance.

# Low carbon stations for low carbon cities

Promoting construction, renovation, retro-fitting  
and better integration of stations in the urban tissue

Anne Leemans  
Project Leader

João Cruz  
Glenn Frommer  
Milena Ivkovic  
Researchers

September 2015

# TABLE OF CONTENTS

Foreword  
Acknowledgements  
Core Project Team

1. Introduction
- 1.1. Objectives of the report
- 1.2. Methodology

## Part I: Stations and Design

2. Typical features of a station
3. Design versus functioning and performance of stations
- 3.1 What is the preferred approach in design : cradle-to site or cradle to grave?
- 3.2 Why are low carbon stations desirable?
4. Design for low carbon stations
- 4.1 Design for mitigation of energy consumption
- 4.2 Recommendations for climatisation and ventilation
- 4.3 Recommendations for moving machinery
- 4.4 Recommendations for Lighting
- 4.5 Recommendations for Information and Communication Technologies (ICT)
- 4.6 Recommendations for food storage and processing
- 4.6 Recommendations for Water pumping
- 4.7 Recommendations for Maintenance and keep-up tasks
5. Design for low water use
- 5.1 Recommendations about the use of water by the station
- 5.2 Recommendations concerning the embodied water
- 5.3 Recommendations concerning the operational water
- 5.4 Recommendations regarding transport of water

## 6. Design to decrease CO2 emission

- 6.1 Recommendations concerning the CO2 footprint of the station
- 6.2 Recommendations on the material-embodied-CO2 of the station
- 6.3 Recommendations on operational CO2 emission
- 6.4 Waste connection systems

## 7 Design for better public health

- 7.1 Active Travel and gender
- 7.2 General Recommendations

## SPIN UP: the combination of culture, complexity, context and community-oriented leadership

- 1. Culture and complexity
  - 2. USE RUSE ABUSE
  - 3. Community-oriented leadership, the status of the operator as main actor:
  - 4. The practice of SPIN UP
- References

## Part II: Land-use solutions

### 8. Introduction

- 8.1 Function, Structure Type, Site Development Character, and Ownership.

### 9. Low carbon land-use solutions – in general

- 9.1 How and which land-use instruments can be deployed to change this?

### 10. Low carbon land-use solutions – for the station areas

- 10.1 Transit oriented development
- 10.2 Different land-use patterns for different travel mode I
- 10.3 Public spaces in the station areas and land-use
- 10.4 Complex station structures and land-use
- 10.5 Pro's and con's of land-use strategies as low carbon reduction instrument

References





# Foreword.

As professionals we view design not only as an activity to create beauty out of chaos but also as a mean to increase the quality of life of people as individuals and people in society as a whole.

As citizens and design professionals we moreover feel we have an obligation to undertake what is within our power and capacity to help mitigate climate change.

We started doing research from the perspective of passengers on the link between perceived security and design of urban public transport stations and developed a methodology to improve perceived security in and around stations. It has proved to be important not only to increase the number of passengers and users of the station but also to boost the turn-over of retailers in the station.

This was our objective when we started back in 2004.

How can we positively influence the attraction of public transport to passenger?

How can we make sure more people trust public transport.

The next question was, considering the need for accessible mobility is location and climate independant, how can we contribute to a better integration of stations in the urban tissue both in the global South and North. It was decided this would require a transversal approach of energy and waste management, urban planning, mobility and land-use while at the same time remaining alert for input from the public health community, gender and age aspects as well as cultural perspectives.

The result is in your hands. It can be improved and updated at all times. We welcome your comments via [www.ydesignfoundation.org](http://www.ydesignfoundation.org). Nevertheless, we hope you will not only find this outcome helpful but also apply the recommendations and tools this report hands over to you!

Anne Leemans

[anne.leemans@ydesignfoundation.org](mailto:anne.leemans@ydesignfoundation.org)

# Aknowledgements.

On behalf of YellowdesignFoundation I would like to warmly thank Mistra Urban Futures and Trafikverket for their generous funding and unconditional support in the development of this research program.

I address particular gratitude to Susanne Ingo and Alice Dahlstrand for their perseverance, diligence and precious feedback to make this research program a success.

Next, I would also thank Ann-Louise Hohlfält, Chantal De Smedt, Charlie Martial Ngounou, Chavindi Senanayake, Elisabetta Troglio, Ellinor Dässman, Florian Vallée, Ha Dang, Juhyun Lee, Klås Johansson, Liesbet De Keersmaker, Mats-Ola Larsen, Mano Dharmalingam, Mira Andersson, Mohammed Afkar, Mohammed Hilmy, Nayoka Martinez-Backström, Paul van Doninck, Quang Nguyen, Sean Armstrong and last but not least Nady Bilani for their critical approach, expert advice and continued support.

Anne Leemans



# Core Project Team.

## **dr. Joao Beles Cruz**

João graduated in Interior and Industrial Design from the University of Lisbon, Portugal in 1997. He received his Master's Degree in Product, Materials and Product Management by the University of Aveiro, Portugal in 2005. His thesis was entitled, "Design against crime in the public transportation networks of Lisbon and Oporto areas" .

Joao obtained his PhD at the University of Aveiro in 2015 after a three year research on "The role of design on the physical comfort and psychological well being of passengers on long haul trains in Portugal".

He also held the position of Industrial and Interior Designer from 1995 to 2001 in four locations: Lisbon, Vila Nova de Gaia, Helsinki and Stockholm – always in the service and manufacturing industries .

Since 2001, Joao has pursued an academic career, teaching Interior and Industrial Design Courses at the Fine Arts Faculty of the University of Lisbon.

João has been teaching subjects as Human Factors, Ergonomics, Materials & Manufacturing Technologies, Interior design and Lighting Design.

## **dr. Glenn Howard Frommer**

Glenn is amongst the pioneers of the sustainability and the environmental movement, having worked in the field for more than 30 years. His understanding and application of corporate risk management and corporate reporting have helped set the gold standard for sustainability strategy development and management. In the course of his career, Glenn held senior executive positions with the Mass Transit Railway Corporation, Vipac Engineers and Scientists and Dampa A/S. His extensive cross-sector and cross-industrial experience extends throughout the international arena, specifically in Europe and Asia-Pacific.

Glenn has worked with the Global Reporting Initiative (GRI) since 2000, involved in drafting technical supporting documents to the GRI G3.1 and G4 guidelines.

He has also worked on the development of the AccountAbility AA1000AS standard, Bsi 8900 for sustainability management systems and the ISO 26000 standard for Corporate Social Responsibility (CSR). He has provided a number of reviews of GRI G4 and Integrated Reports to Hong Kong, mainland China and multi-national companies in the last 12 months.

He has lived and worked in Hong Kong, Australia, Denmark and the United States. His knowledge of the fields and wide network of international contacts gives him a thorough understanding of the different cultures, customs and governance issues. Additionally, Glenn holds a PhD in Aerospace Sciences, is a Fellow of the International Institute of Acoustics and Vibration, the Honorary Chair of the Sustainable Development Commission of the International Association of Public Transport, a member of several international and local professional bodies as well as being a Fulbright Fellow. He is a published author and is currently the Senior Advisor to the GRI Focal Point in China. He is also a founding partner of the Sustainability Partnership, a consultancy firm in Hong Kong that focuses on taking reporting companies into the next phases of sustainability development.

## **Milena Ivkovic, ir**

Formally trained in architecture, Milena Ivkovic is an experienced researcher and designer in the field of public space design. Her broad view on urbanity, technology and end-users has been shaped by her own multicultural background and work experience in diverse international environments, from Netherlands and the Balkans, to Africa, China and Japan.

In 2011, Milena focused on developing new planning formats, such as urban gaming - a tool that uses gaming principles to understand and change the built environment. Milena has successfully developed a series of interactive urban gaming workshops, resulting in public space action plans, collaborative design projects and urban policy adjustments. These specific workshops bring different stakeholders to the table and help initiate an innovative and open urban planning process.

Since 2010, Milena worked on several Yellow design Foundation research, urban space and mobility projects.

Between 1999 and 2010 Milena worked for renowned Dutch architecture and urban design offices of which Kuiper Compagnons and Rein Geurtsen & Partners, as well as for the City of Rotterdam Public Design Service.

Between 2000 and 2005 Milena contributed to several international urban planning projects in China, North Africa and Europe. Milena's share in these projects included public space design, integration of public transport networks and preservation of natural eco-systems within the built environment. On other assignments between 2001 and 2007 Milena was in charge of public space design and advanced spatial analytics for the cities of Wuhan, Suqian en Hangzhou.

Born in Belgrade, Serbia, Milena received her Bachelor of Architecture and Master of Architecture and Urbanism degrees at Faculty of Architecture, University of Belgrade. Next to teaching urban design at the Department of Urbanism of the same university, she collaborated with the Serbian Institute of Architecture and Urbanism (IAUS). Her research included exploring the reconstruction of public spaces of the the post-communism cities.

## **Anne Leemans**

Anne graduated in applied linguistics in 1981. She has been Yellow design Foundation's Secretary General since 2004. Her main concern is to make experts in different fields linked to mobility and urban planning integrate their findings in the interest of sustainability and to the benefit of users: passengers, pedestrians and cyclists, but also other stakeholders of quality public space.

Between 2004 and 2007 Anne and her team at Fontana coordinated on behalf of Yellow design Foundation and with the backing of UITP ([www.UITP.org](http://www.UITP.org)), and several other international partners a research programme conducted in 6 European countries and focused on the link between perceived security and design and ultimately lead to the development of SPIN-UP (Security Perception in Intermodal Stations for Urban Public transport) methodology.

Since 2010 Anne has coordinated research projects funded by the Paris-based UIC ([www.UIC.org](http://www.UIC.org)) on the design of major European interchanges with the objective of developing a toolbox aimed at operators, authorities, urban planners, architects and real estate developers as well as a benchmark of major interchanges in South and South East Asia.

Since 2012 Anne has coordinated the Low Carbon Stations project on the contribution of mobility to low carbon cities with the backing of Mistra Urban Futures, Sweden.

Additionally, since February 2012 Anne's team has been adopted in the Sustainable Urban Development experts' network of UN Habitat.

**Yellow design Foundation** is an international research platform that since 2004 has developed research on the link between perceived security and design as well as on other topics linked to climate change, mobility and urban planning.

Between 2004 and 2007 the Foundation developed research on the link between perceived security and design in which Istanbul Ulasim metro operator participated. The results of the research program lead to the definition of SPIN-UP, a methodology to assess the quality of public space that has since been applied in several countries in Europe and Asia.

In 2010 Yellow design Foundation carried out several research programmes (in collaboration with Architecture TU Delft) concerning intelligent interchanges. In four European countries (Italy, Germany, France and Spain) we made a toolkit for design and/or renovation for the four major interchanges: Milano Centrale, Berlin Hauptbahnhof, Paris Montparnasse and Madrid Atocha.

All of these interchanges are offering high-speed train services in combination with regional rail, metro, bus and tram services. The recommendations presented reveal the similarities and differences between the interchanges, and offer a platform for improvements.

In 2011 Yellow design Foundation carried out an even more ambitious and complex research on the design of intelligent interchanges in four Asian countries: in India, China, South Korea and Japan. Despite the cultural, geographical and economical differences, it is clear that the need for quality interchanges is the same and growing, especially in major urban areas. We benchmarked major infrastructural hubs such as Delhi Central, Mumbai CST, Beijing South Station, Shanghai Hongqiao, Seoul Central and Tokyo Central, but we also collected data on other, smaller, but nevertheless vital interchanges such as Delhi's Nizamuddin Station and Seoul's Gwangmyeong Station. The collaboration model (Yellow design Foundation collaborated with Kogakuin University in Tokyo on this research) proved again to be a valuable asset in understanding the complexities of multimodality in an Asian context and formulating the required recommendations.

Yellow design Foundation is member of the UN Habitat Sustainable Urban Development experts network and partner of UN Habitat Urban Planning and Design Lab.

# Introduction.

Trafikverket & Mistra Urban Future, following straight on from the climate policy resolutions under the Kyoto protocol and the European Union burden sharing which seek to reduce green gas emissions by around 16 per cent below the 1990 level by 2020, commissioned this independent report on Low carbon stations for Low carbon cities. While the reduction target should be encouraged, this is not sufficient to meet the 2 degree cap that was agreed at the COP in Copenhagen in 2009. A scientific target based on what is needed is an 80% reduction in GHG by 2100. Price waterhouse Coopers has calculated this as a 6% year on year decrease of GHG. 16% will not get us there. An alternative method of calculating the reduction needed is to assume the 80% reduction for stations and then back-cast to what is needed for the realistic year on year reduction.

Based on domestic and international experiences of low carbon station development, using the examples of station areas of Stockholm, Malmö and Gothenburg of which the results have been compared with figures of cities in Sri Lanka, Vietnam & Cameroun, this report proposes general strategies, specific requirements and key measures with highest potential in the design of station areas as well as for more efficient planning of smart movement of people/passenger and goods within and to and from the city so that transport flows can contribute to the downgrading of urban carbon dioxide emissions.

## 1.2 Methodology

As a start our team visited and/or sourced data from Malmö, Gothenburg, Stockholm in Sweden as well as in Matale, Kandy and Colombo in South Asia, Yaoundé in Cameroun and Da’Nang in Vietnam

We compared the existing urban mobility systems. The visit reports are available upon request.

The resulting reports offers a comprehensive methodology, tools and a wide range of recommendations, standards and guidelines and planning for future station construction which should be well integrated in the urban tissue and in such a case the station could be also a center for resources and higher profits.

The scope of “Low carbon stations for low carbon cities” project was depicted as the ‘transportation nodes’ of all transportation modes. The general goals of the project were said to be the description of recommended design solutions to improve (to reduce or mitigate) the carbon footprint (also named environmental bill) of public transportation stations.

This research started with the theoretical review of specificities of stations, providing definitions of design disciplines and their correlation with the functioning and performance of stations based on different approaches cradle-to-site or cradle-to-cradle. It analyzes design principles for better

public health and puts particular emphasis over the low carbon land-use solutions for low carbon city development. This research tries to provide a theoretical basis for low carbon station solutions.

The general context

This report aims at promoting the renovation, construction and better integration of stations in the urban tissue as well as indicating the interdependency between urban mobility, urban planning and public health conditions. Its overall objective is to provide practical recommendations to decision makers namely public and private sector stakeholders, designers and urban planners within the context of a greener environment and sustainable development as well as to ensure proper reporting on the achievements during construction and operations of the station.

In order to become a low carbon city, it is essential to tackle the threats related to the emission of CO<sub>2</sub> by all kinds of sources in general and in particular by the one derived from public transport stations whom successive phases of its life-cycle from building to operation, refurbishment and decommissioning have an impact on the environment.

Thus, the full integration of the retrofitting and maintenance of low carbon stations/transport systems is set out the full within the context of the design and urban development of the station environment as an objective to help address and overcome the numerous challenges posed by global environmental problems.



## Part I Stations and Design

### 2. Typical features of stations

A station can be defined as “a building or place where buses, trains or other public vehicles stop so that passengers can get on and off.” On the same compound can be found also “particular services or activities.” Ultimately, a public transport station is any built interchange between two or more modes of transport (one, at least, being a public mode). Station is where a traveller transfers from one transportation mode to the next along a given trip. For the purposes of this text a station is as much a big complex and multimodal interchange (e.g. an airport+rail+bus+taxi+car+bicycle+boat station) as

a bus/tram flagpole on the sidewalk of a street (i.e. the traveller transfers from the soft mode that are his/her feet to a vehicle or vice-versa). Apart from their role in modality, for visitors, users, passengers, passers-by, stations are places to meet, greet, agree and/or even disagree. Stations form hugely varied universes with each specimen carrying its own particular characteristics of size, transportation available modes, age of the premises, construction methods, local climate, number of passengers, services available, geographic location, operation type, etc. Nevertheless the common characteristic among all station types is that they all serve two or more modes, one, at least, being a public transportation mode.

Some of the design recommendations of this paper are suitable and reasonable for a limited number of stations types, and, of course, at the same time are inappropriate and unreasonable for all the remaining types. Only a few recommendations are universally pertinent.

# 3. Design, functioning and performance of stations

In broader terms, the meaning of Design in this paper refers to all the trades and professions needed to conceptualise and prescribe in detail, at a blueprint level, the characteristics of shape, aspect, size, operation mode, composition and behaviour of the premises. It comprehends the specialised ramifications of “Land-use and Urban planning, Landscape Architecture, Architecture; Interior and equipment design; Communication and Graphic design; Civil, Mechanical and Electric Engineering, that are required to determine the stations precise characteristics.

In order for the design to influence the way a station operates three typical contexts should be considered :

- When a new station is being developed from scratch [which comprehends both i) a brand new autonomous station or ii) a new station built to replace/compensate for the de-commissioning or obsolescence of an older nearby station];
- When an existing station is fully or partially refurbished (either to change its capacity, size, attend technological or societal evolutions, adapt its mission, extend its service-life, update its atmosphere or image, recover from serious damage, or adjust to the expected people’s requirements);
- When new modules or units are added to an existing station (built environments or equipments that where not included on the original design).

- When Planning a new station or upgrading an existing station an assessment to flooding should also be included and other potential impacts from climate change (increased winds, higher temperature), and the potential to provide resiliency in emergency situations e.g. shelter, storage of food and bottled water in the event of flooding etc.

Whenever, either of these four contexts occurs, the proper conduct of the design phases can affect the “behaviour”, the performance and the attractiveness of the resulting facilities and, thus influence the environmental footprint of the station and of the surrounding community.

## 3.1 What is the preferred approach in design : cradle-to-site and/or cradle-to-grave?

Cradle-to-gate, cradle-to-site and cradle-to-grave captions were adopted by the sustainability jargon to illustrate how comprehensive the possible approaches to a given situation are. The cradle-to-gate approach measures the environmental costs, social costs and the economic costs incurred all along the production of a given material or product from the raw material extraction to the delivery of the tradable good at the gate “door” of the manufacturer’s.

The cradle-to-site approach goes a bit further as it takes into consideration all the costs up to transport and the in-site installations of the material or product at their intended location in a building<sup>1</sup>.

The cradle-to-grave approach spreads a lot further by incorporating all the costs from extraction of raw materials to the end of the useful life (or service life) of the material or product. In doing so, it has to: i) compute an expected length for that life, ii) know the particular requirements to preserve the material or product in good operating order, iii) know how the material or product will be daily used, and iv) know which is the disposal destination of every part/mass once the lifecycle comes to its end.

---

1. In the case of consumer products, this approach goes up to the placement of the product on the retailer’s shop.



Cradle-to-grave is the most complex approach, the one that faces more uncertainty, but also the one that more closely depicts the real and full burden-and-benefit of products and materials. Given the average length of the stations' lifecycle (a time frame rarely defined in precise terms but frequently said as "long"), the environmental costs of the station operation are chiefly important. In medium to large stations also the environmental investment costs (also named capital costs: the cost to build and commission the premises) can also assume a very relevant position.

It is recommended that designers in all projects, prospect a cradle-to-grave approach to drive their decisions, no matter how precise the quantification of environmental costs can be. The more modest cradle-to-gate and cradle-to-site approaches should be the designers refuge if the information disclosed by the station owner is not enough nor reliable to anticipate the premise's lifecycle. It is known that "given the salami-sliced nature of the design, procurement, construction and operation of a structure, it is often hard for an individual stakeholder to exert a strong influence" (Gieseckam et al, 2014, pp.210), but in what concerns the reduction of the stations environmental footprint, all tentative efforts are worthy. As more and more lay persons and designers come into contact with pragmatic design strategies and design solutions that mitigate that footprint, the more likely it is that future stations come to be good stations. From the practical point of view, the calculation of the CO2 bill of each part of the building/product is still a very rough undertaking. Regardless of the approach taken, it is recommended to implement a simple platform to establish a carbon 'budget' and track its achievements for the station design and operations. (Further developed in Appendix A.)

## 3.2 Why are low carbon stations desirable?

Low carbon stations are highly desirable because stations can positively contribute to improve the carbon footprint in a way for it to be lighter through a diverse array of tools and measures. The present paper considers strategically three main objectives to produce "Low carbon stations for low carbon cities" :

- 1) The first one is to produce attractive stations that are capable to captivate in the near future more passengers for the public transportation networks in order to alleviate the noxious effects of people's "automobility" (road traffic of private cars used to carry people) in urban and non-urban areas. This objective aims to reduce the CO2 and environmental footprint of citizen's mobility by the "modal shift" from the private automotive mode to soft and public transportation modes. In short: to generate stations apt to foster the attractiveness of public transportation.
- 2) The second one is to produce stations that are premised with the lowest possible CO2 footprint for their intended type of use. This is intended to mitigate, as far as possible, the emissions derived from the successive phases of the stations life-cycle; from building to operation, to refurbishment and to decommissioning. In short: to build useful premises that would not just cause the lightest possible damage to the environment but with the integration of green station roofs and with the greening of the station environment, can also act restoratively (eg green station roof, greening of the station environment).
- 3) Finally, the third one is to produce stations that can act for 3 – 4 years as showcases or live examples of the best practices available for the mitigation of the CO2 footprint in the building and mobility sectors - showcases of viable and reliable design solutions only. This means to gear up the development of skills within the countries' or regions' sectors involved in design, construction and facility operations, as well as focus on a more educational role of the station in society, influencing its citizens towards the best possible and desirable evolution of the material culture and people's relation with it. In short: to turn stations into flagship entities for a low carbon existence.

# 4. Design for low carbon stations.

Mainly for elderly, disabled or otherwise fragile travelers, walking distances and level changes are a defining element in the decision process regarding the journey.

The design disciplines required for the development of the stations can influence the potential attractiveness of the resulting stations by:

- Focussing on the physical comfort and perceived wellbeing of travelers.
- Regulating the ease and convenience of the premises in order to facilitate the inter-modality of the station.
- Affecting the perceived security at the premises (SPIN UP recommendations as Appendix to this report).
- Tuning how easy and how practical the orientation & wayfinding of people within the premises is.
- Shaping the effectiveness/adequacy of the station's shape for its intended use (how well does the building perform as a station).
- Determining the maintainability of the station.

The design disciplines called upon for the development of the stations can, at the same time, affect the environmental footprint of the station because their decisions influence:

- The type and amount of energy used by the station.
- The use of water by the station.
- The global CO<sub>2</sub> footprint of the station<sup>2</sup>
- The global energy footprint of the station<sup>3</sup>.
- The possibility to implement (or not) an efficient waste collection system (one that channels materials to recycle or to fuel extraction/use). If a waste collection unit is built within the station, it should be in conformity with international fire security regulations.
- The durability of the station components.
- The type and lengthiness of the tasks and the equipment that are required to perform the daily operation of the station.

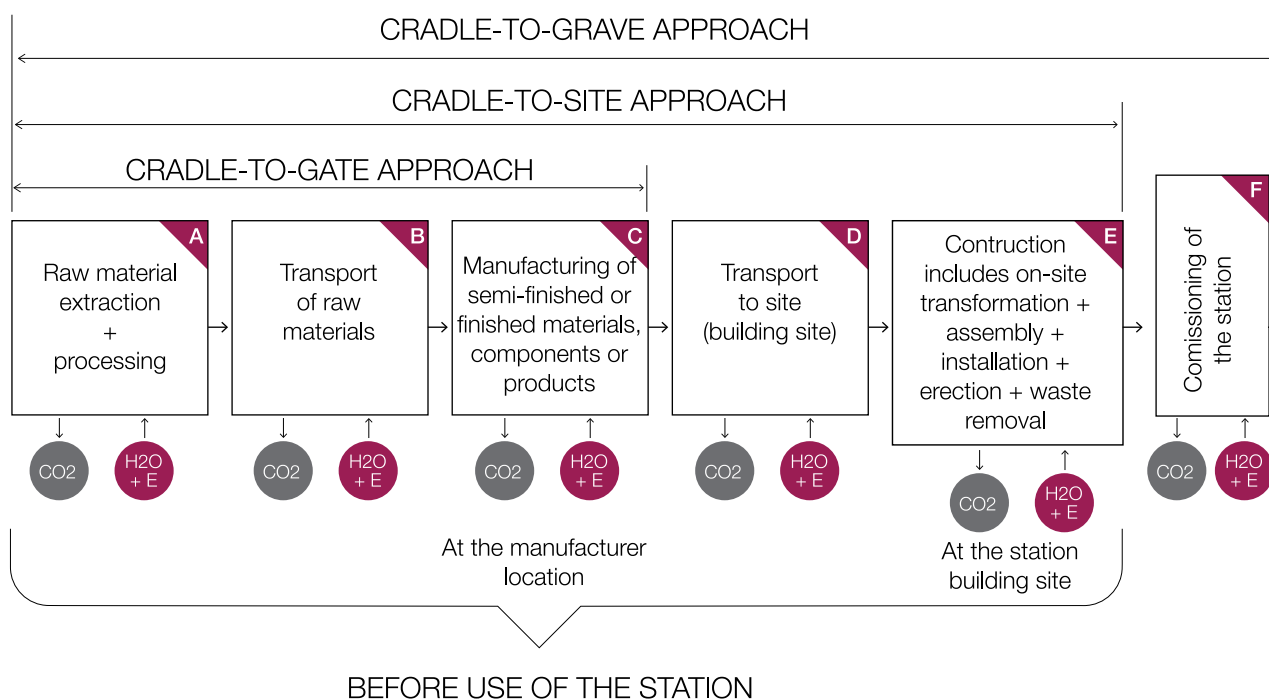

2. The global CO<sub>2</sub> footprint of the station is the sum of the embodied CO<sub>2</sub> and the operational CO<sub>2</sub> of the station. The reader will find these two concepts later on this text.

3. The global energy footprint of the station is the sum of the energy embodied on the station's building materials and the operational energy. The reader will find this two concepts later on this text.

- The environmental impact of the station on its immediate surroundings (eg: effects on wind direction and regimen, sun exposure, heat impact, production of shadows or sun light reflections, the effect on local water flows, noise emission, road and pedestrian traffic, human presence and activities, etc)

The design disciplines can, further, influence the ability of the station to act as flagship station for the low carbon future. To fulfill this aspiration the designers shall expose to the visitor's sight the design solutions that were materialised in order to mitigate the stations environmental footprint. Those prominent design solutions shall be sound, down-to-earth, practical, subtle rather than blatant and indisputably positive contributions for the user's comfort. If any of those design solutions suggest any detrimental or negative aspect, then, it should not be displayed to the visitors sight.

Current short, mid- and long-term projections for global energy demand still point to fossil fuels being combusted in quantities incompatible with levels required to stabilise greenhouse gas (GHG) concentrations at safe levels in the atmosphere.

All technologies along the Carbon Capturing System chain whereby up to 90% of the CO<sub>2</sub> emissions produced from the use of fossil fuels in electricity generation and industrial processes are captured, transported and stored and thus prevented from entering the atmosphere are available. They have been in operation in various industries for decades, although in relatively small scale. However, for the sole purpose of limiting climate change, these technologies have only been put together in industrial scale (captured and stored per year) in a small number of installations. No large-scale installations exist yet in electricity production, although two notable large-scale projects are expected to start soon. None of the stations which are part of this research have actively included Carbon Capturing Systems.

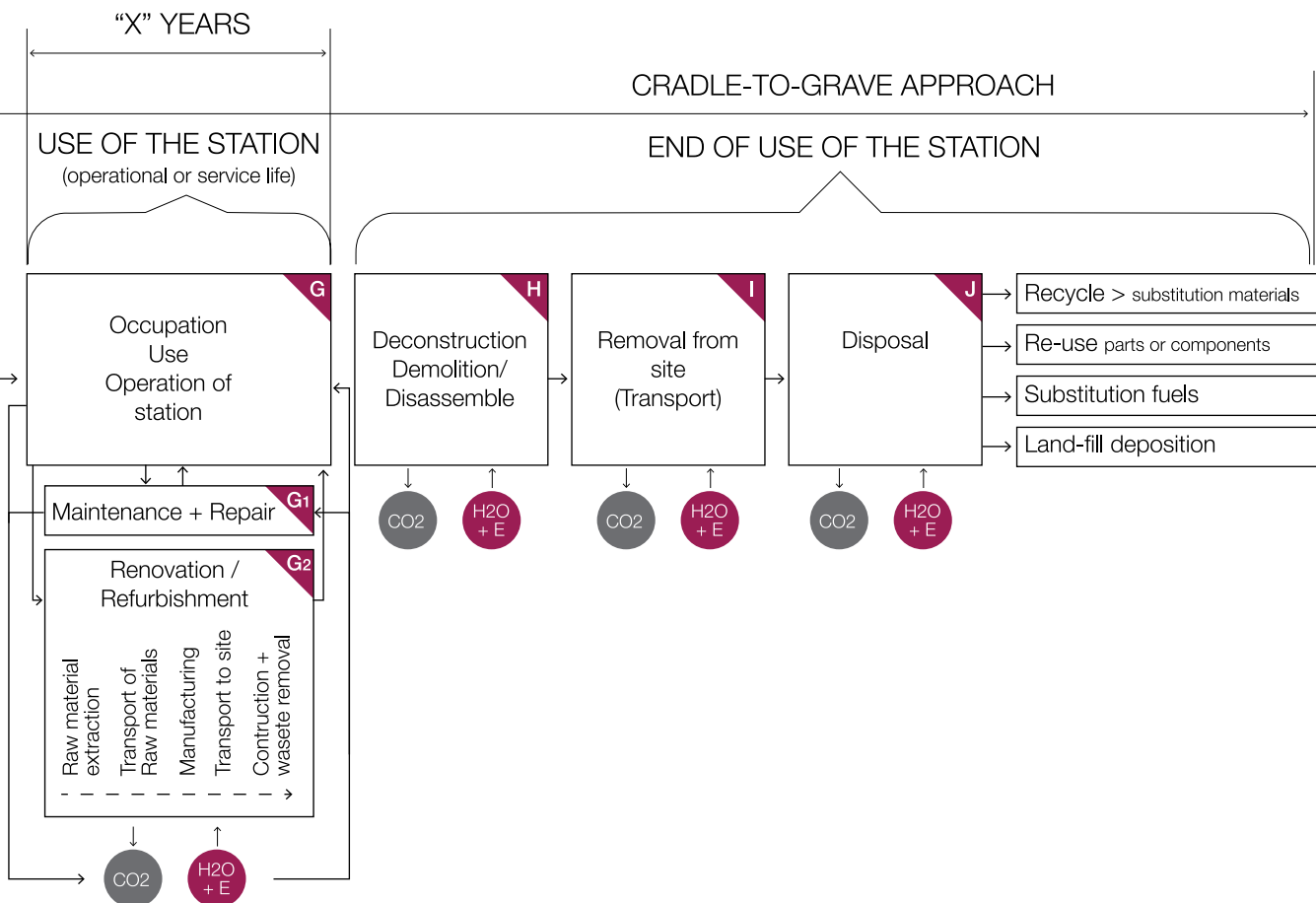

## 4.1 Design for the mitigation of energy consumption : type and amount of energy used by the station.

Stations require energy to produce and operate. The overall energy demanded by a station should be divided into two different categories:

- I. Embodied energy (the energy spent by the manufacturing, application and preservation of the building materials used to materialize the station premises),
- II. Operational energy (the energy directly and daily used to operate the station),

The lonely flagpoles that signal bus stops , trams stops and taxi stands are the single type of stations that do not consume operational energy. They are even lit by third-party luminaires - the street lamps. Apart from this simple form of stations, all interchanges, depending on their location, size and functions, consume at least one type of operational energy.

Stations conventionally consume:

- **Electricity.**  
Usually received from the local distribution network and produced from a mix of sources: fossil fuels (oil/gas/coal), hydro-generated, wind-generated, solar-generated and/or nuclear-generated. Few stations have the capability to generate electricity; this is limited to stations equipped with fuel-powered electrical generators (usually for sporadic use, during black-outs on the grid, along peak consumption periods or use on building/repair sites) or, more recently, stations equipped with photovoltaic cells. At the moment this self-produced electricity is not enough to provide self-sufficiency for the stations. The photo-voltaic power produced by stations is usually sold to the local grid manager; it is a source of monetary income and not a source of immediately usable power.
- **Gas, petrol, diesel or “mazout”.**  
Either piped or stored in tanks, liquid and gaseous fuels are used in medium and large stations to burn and generate central heating, sanitary water heating, to cook (if restaurants/ canteens exist within the station) and to power electric generators (if any).

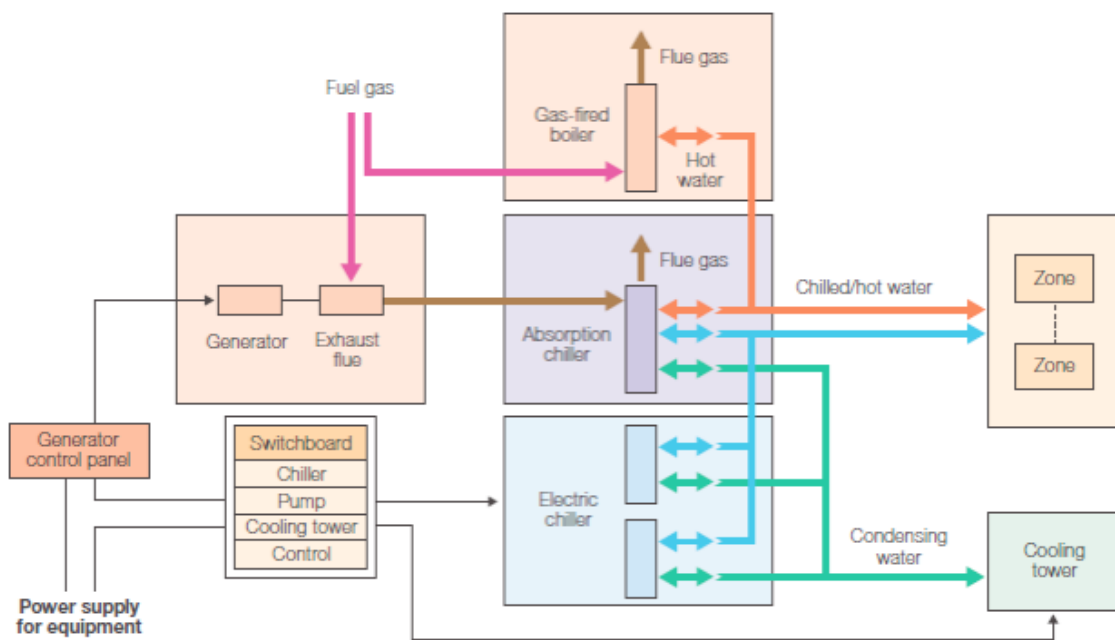

CHP system scheme, Beijing South Station image source: Arup Associates

- **Wood and wood pellets.**

Few stations continue to use wood and wood waste products (also called “biomass” or “phytomass” in the energy sector jargon) as fuel for small heating devices. Those devices are either central heating boilers or space-heating appliances (e.g. back-boilers, stoves). Despite being a type of heating solution with very little CO<sub>2</sub> net emission, its use is generally limited to small installations due to the burdens associated to fuel handling and transport, the ash handling and the amount of fine particles incorporated in the smoke it produces<sup>4</sup>.

- ***District heating and cooling.***

Stations in areas served with district heating grids use those sources to heat their buildings and sanitary water. District cooling is used to power (by heat exchangers) air conditioned systems or radiant cooling ceilings. Despite being an old set of technologies, district heating and cooling is still nowadays greatly limited to dense urban areas of northern and eastern Europe, North-America and South-Korea. District heating grids distribute piped hot water that has been heated using the surplus/excessive heating (also called “recycled heat”) from i) the machinery used to produce electricity in electric power plants (thermal or nuclear), ii) from solar collectors or iii) from geothermic sources.

District cooling distributes piped cold water that was made cold in a) heat-powered chillers or b) was geothermic captured (already cold). Due to its nature, those grids are always local/regional networks that spread for a few kilometers from an important source of hot or cold water. The transport of hot/cold water for long distances is not sustainable.

## Combined Heat and Power System (CHP)

Beijing South Station uses the CHP, Combined Heat and Power System, also known as “power co-generation”. Co-generation is applied to processes creating simultaneously both heat and electrical power from single fuel supply. Single fuel supply is mostly natural gas, used for the gas-based turbine or engine, which then drives an electrical generator and makes practical use of the heat as its by-product. This actual heat-waste can be used for other station systems, such as cooling and heating, as well as developing the heated and chilled piped water network for a district heating and cooling system and therefore provide an integrated energy service. By cutting the use of coal fuel the CHP system improves environmental protection and reduces the amounts of CO<sub>2</sub>, nitrogen oxides and sulphur dioxide.

Though only viable for big station, using CHP system can cater for over 45% of the overall electricity demand of the passenger station (not the train operations) and its auxiliary buildings. Energy efficiency of CHP is high (above 80%) with less transmission loss in the surrounding district.

## PV (photo-voltaic) roof panels

The large roof size of newly build interchanges (like Shanghai Hongqiao and Beijing South, or Berlin Hauptbahnhof in Europe), as well as the surface of the platform canopies (Tokyo Station), make it very suitable for solar power generation systems. Hongqiao Station has currently the worlds largest integrated PV system, that can produce 6,5 million kilowatt-hours (kWh) of electricity per year. New generation of integrated PV panels can be installed with the transparent glazing material, allowing enough daylight through roofs and canopies.

When integrated early in the design, PV panels can become a part of distinguishing station roof aesthetics. When applied later as a part of station renovation and/or improvement, they're mostly placed on the platform canopies.

At Tokyo Central, as a collaboration project between JR east and the Chiyoda local municipal district, solar panel systems were introduced on the roof of Tokaido line platform, at Feb 2011. Consisting of a total exposed area of 3,846 m<sup>2</sup> for output of 453kw, effective generation per year is 340MWh/year, CO<sub>2</sub> reduction for 101t/year and the panel system covers still 0.3% of total energy consumption of Tokyo Station. With 4 monitoring system displays located at inside of the station, the energy production can be observed in real time.

PV panels are costly, but completely powered by a renewable source, i.e. the sun. Today they only cover between 5 % (Beijing South and Berlin Hauptbahnhof) and 10 % (Shanghai Hongqiao) of the station building's daily energy needs, but the daytime operations PV system can serve as the station's auxiliary power plant to cope with any supply fluctuations from the local grid. (Source: UIC Asia Benchmark, Yellow design Foundation, 2011)



*Shanghai Hongqiao Railway Station*

## Energy Bill

The composition of the energy bill of stations is quite varied and depends on: i) the local climate, ii) the type and size of the premises, and iii) their level of mechanisation (i.e. the amount of machinery, automated and active equipments used on the premises). Furthermore: it depends also on the iv) energy efficiency of the machinery used to operate the stations (older machines are usually less efficient than newer ones), v) on the level of thermal insolation of the facilities and vi) the heat gain from its normal operation.

It is reasonable to expect that the biggest share of the power bill of an underground station comes from lighting and, perhaps, water pumping, heating and ventilation. It's also rational to expect heating to have an important impact on the energy bill of a station in a cold location, and air conditioned in a warm climate. Nevertheless we could not gather yet a complete picture of the relative weight of each energy use on the heterogenous universe formed by public transportation stations. But it's possible to group the use of energy in stations according to its purpose:

- **Climatisation and ventilation** (heating, cooling, moisture control, ventilation/renovation of interior air, shelter from aggressive weather when outdoors<sup>5</sup>),
- **Moving machinery** (lifts, escalators, lifting platforms, travelators, automatic doors, turnstiles, gates, luggage handling machinery),
- **Lighting** (functional, emergency, decorative and retail lighting)
- **Information and Communication Technologies (ICT)** (data networks, computers, telephone and radio networks and their dedicated cooling requirements, ticketing machinery, ATMs, public-address systems, electronic displays, ticket inspection apparatus like ticket and barrier-gates, CCTV, luggage and passenger inspection machinery).
- **Food storage and processing** (cooking and warming food, refrigeration of chilling rooms/ cabinets used to store food/drinks in shops or canteens).
- **Water pumping** (pumping of drinkable water, sanitary water, underground/rain water, sewage).

- **Maintenance and keep-up tasks** (cleaning, replacement of damaged parts, waste removal).
- **Signalling and traffic control** (lights and radio signals used to control the traffic of vehicles approaching or within the station).

From this general grouping of energy destinations we can draw generic recommendations for the design of stations.



Tokaido line platform

<sup>5</sup> E.g.: fans and water sprinklers for terraces on hot environments, or radiant heaters for terraces on cold environments.

<sup>6</sup> For a description of the concept and its pragmatic solutions see Almusaed (2011), Hyde (2007) and Olgay (1963), Izard (1983)

## 4.2 Recommendations for climatisation and ventilation.

- Promote passive (also called natural) climatisation, when possible. Once passive climatisation consumes very small amounts of energy, it is preferable to artificial climatisation. In order to reduce the urban heat impact in open urban areas:
  - provide green space, green roofs and green walls
  - provide green and water environments
  - avoid wall-to-wall stone, bituma or concrete environments
- Climatisation following the principles of bio-climatic architecture<sup>6</sup>, namely replicating ancestral and vernacular design solutions with modern materials and knowledge, should be promoted. This requires detailed knowledge of the local weather patterns. Bio-climatic designs adapted to cold or warm, dry or wet or windy climates abound and can be implemented both in densely occupied /consolidated urban areas and in rural/isolated locations. Around twenty different bioclimatic design principles for passive heating and passive cooling are well understood nowadays. ([www.craterre.org](http://www.craterre.org)) When the application of those principles is not enough to enable a modern level of thermal comfort (usually in peak hours, peak seasons or extreme weather), artificial climatisation should be installed as a supplementary system. The passive bio-climatic conception should be the base-infrastructure and the energy-intensive artificial climatisation should be called only as a supplementary/auxiliary resource.
- On the design of interior spaces, insulation levels, air renovation, and heat gains should be considered at once, under an integrated approach.
- On the design of interior or exterior spaces, sun exposure, rain, snow and wind shall be taken into consideration at once, under an integrated approach.

- Artificially climatized areas shall be, always considering the regional context in terms climate, travelers' volume etc, as compact and small as possible. Designs that enable travelers to wait and relax in a centrally climatized room/ area until a few minutes before the vehicle arrival (minimising time outdoors under inclement weather) are preferable to large or dispersed climatized solutions. Travellers will only be relaxed in waiting areas if: i) the size of the waiting area is big and airy enough for the peak-hour flow of people, ii) the waiting area is perceived as secure, clean and comfortable, iii) the route to the boarding bay/gate/platform is reliable, predictable or well known, and iv) the notice of vehicle approaching is reliable, loud and made sufficiently ahead of time.



Stockholm metro station

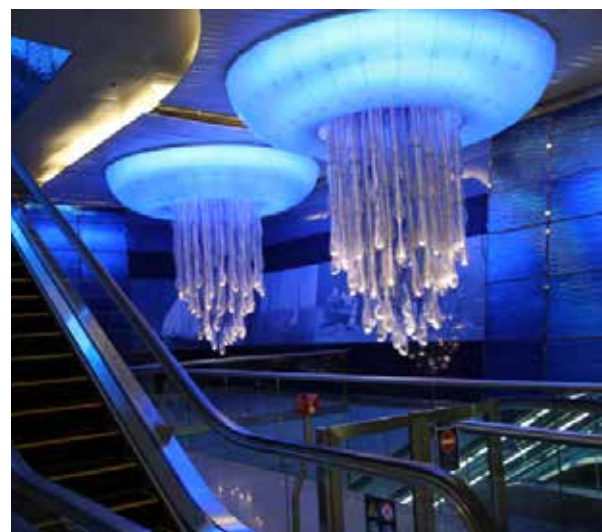

Dubai metro station



- In outdoor spaces (waiting areas, boarding platforms, passages, landing stages) realistic and effective shelter against the weather (sun, wind, rain or snow) should be provided, the year around, in cold, moderate or warm climates. Designers should keep in mind that the warm season in a cold climate or the cold season in a warm climate can be quite comfort-deleting if experienced outdoors. It is also wise to recall that “moderate climates” are not free of rain, chilling wind or burning sun.
- The ventilation of indoor spaces shall be designed to enable a healthy environment: the toxic and unpleasant elements should be swiftly exhausted, as well as the removal of all sorts of waste and bad smells of human origin (odours from food, toilets, cleaning agents, breath, sweat). In practice this implies the monitoring of CO<sub>2</sub> and bacteria levels. Separately and as part of the stations’ maintenance and hygiene plan a set of measures to be taken in case of problematic levels of CO<sub>2</sub> and/or bacteria need to be set out.
- Passive or active, natural or artificial, designed climatisation, should be of variable geometry and allow the adjustment to the fluctuations on the external weather and to the variations of indoor activity. This adjustability can be IT assisted (sensors, computers and actuators) and/or hand operated by staff. Ideally the adjustments (the climatic driving or climate conducting of the building) should anticipate those variations and not solely react to them.
- All forms of i) intelligent equipment, ii) machinery, electric/electronic devices, iii) lighting and wiring, do dissipate waste-heat to their surroundings. The thermal design of the station should consider the cumulative effect of those dispersers and sometimes discrete waste-heat sources. This lost heat can positively assist the heating of the indoors (in the cold season) but can also disturb the ventilation or cooling of the space (in the warm season), not to mention the immediate effect on body comfort of the nearby travelers. To minimise the oversizing of the climatisation systems, when possible, the waste- heat generating devices should be located outside those areas that are being expressly cooled for human comfort. Typically the climatisation systems are designed for a crush load or maximum level. It is important to modularize the components to run the systems as efficiently as possible.
- The climatisation of the station would benefit from a design that integrates vegetation, lawns or flower-pots that: 1) reduces the land sealing/ waterproofing of the built area around the station, 2) produces protective shading for people and walls, 3) reduces the heat gain of surrounding areas due to sun exposure, 4) softens the ambience (ideally) without creating visual barriers. In urban environments those design strategies might locally alleviate the negative effects of the “urban heat islands effect”<sup>7</sup>.
- The physical details of any climatisation design should comply with the public- space-nature of the premises: robust, out-of-reach and easy to maintain details are welcomed.



Oporto Trindade metro station

8 *Bringing sun light indoors always produces heat gain, through the rise of i) mean radiant temperature and ii) air temperature.*

## 4.3 Recommendations for moving machinery.

- Moving machinery should be kept to a minimum. Stations should be designed to minimise the level changes that require escalators and lifts. Slopes and ramps, if conveniently located, well designed and provided with gentle gradients, can exempt lifts and escalators. Considering the growing numbers of aging population, walking distances should also be designed to minimize the need of travelers. On the other hand, the attractiveness of the station's inter-modality directly depends on the level of physical exertion demanded to passengers (with luggage or impaired mobility) while moving from one transportation mode to the next. If the passengers' comfort can not be achieved without moving machinery, then, and only then, lifts and/or escalators should be adopted.

- Moving machinery, if unavoidable, should be designed, managed and announced to passenger in ways that minimise their use. This machinery can be i) placed out of the main pedestrian flow, ii) provided with sleeping-mode (making sure it goes off power if unused for several minutes), iii) reduced on their operating speed or iv) announced as aimed primarily to impaired mobility users, v) provided bi-directionally. Those are common strategies to keep to a minimum the use of peplemoving machinery.
- The handling of luggage and goods within the station should also be carefully designed to enable most of the movement to be carried out by the passengers themselves.

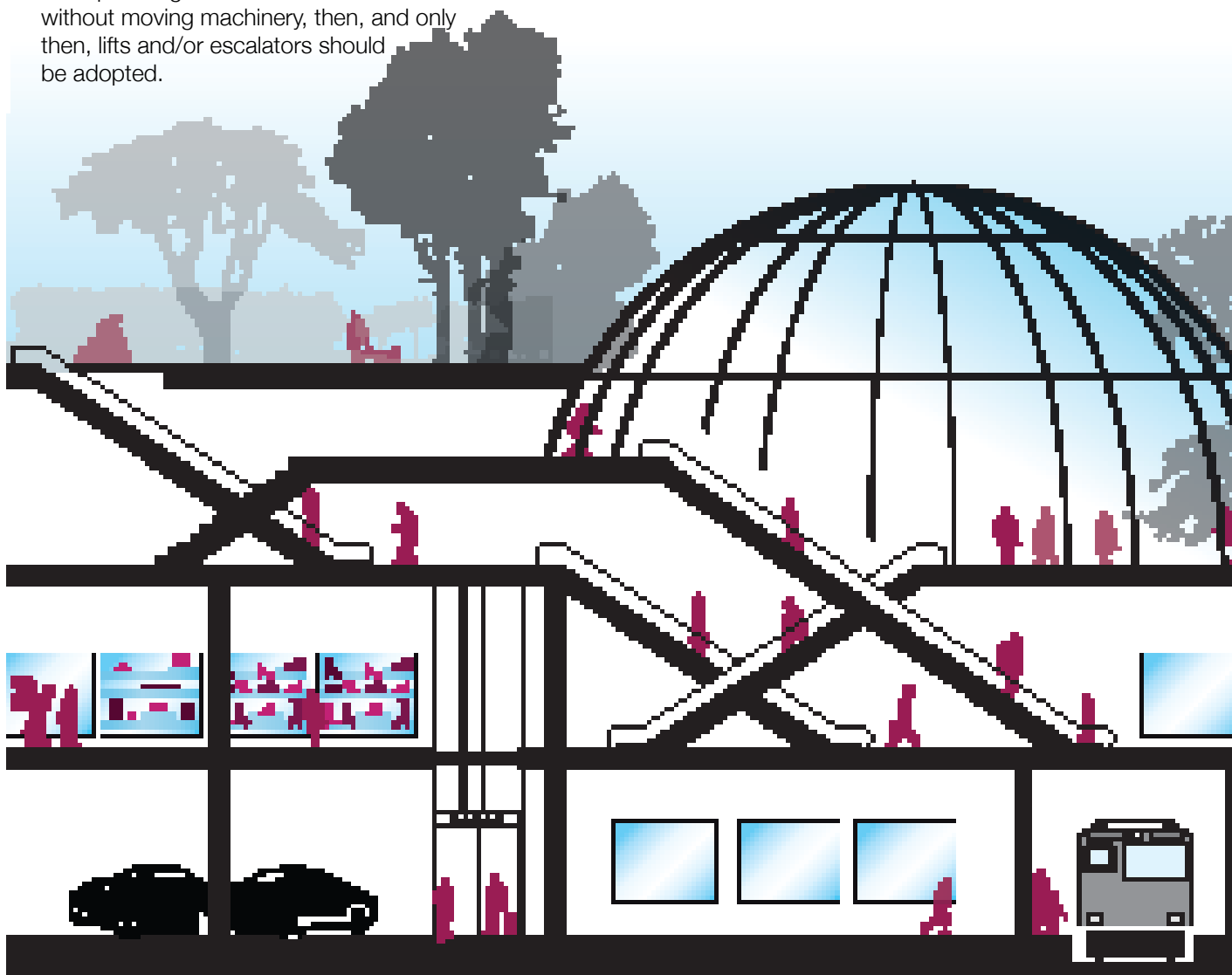

## 4.4 Recommendations for Lighting.

- Promote sound lighting designs that:
  - i) maximise natural lighting input,
  - ii) make efficient use of illuminance and reflectivity,
  - iii) produce comfort and visibility without jeopardizing climatisation<sup>8</sup>,
  - iv) mitigate permanent supplementary artificial lighting
  - v) mitigate light pollution (leaked light or light directed towards objects that don't need to be visible).

- When artificial lighting is required, variable lighting schemes might afford opportunity to optimise electricity consumption., eg Variable lighting schemes enable to switch on and off the luminaires along the day to adjust the lighting output to the momentary demand. The adjustment might be man-operated or automated, the latter being more efficient. Those adjustments can also be used to conduct the passengers activity and presence; people tend to gather in well lit areas. In large stations those areas might be created on the boarding areas or waiting rooms that are under staff supervision. Long or sparsely used boarding platforms (like in some stations) don't need to be uniformly lit along their length, neither well-lit in-between trains if the interval is long. The objective and perceived security should, nevertheless, prevail over all energy frugality; the reduction of the electricity consumption should not be achieved at the expense of passengers' perceived security.

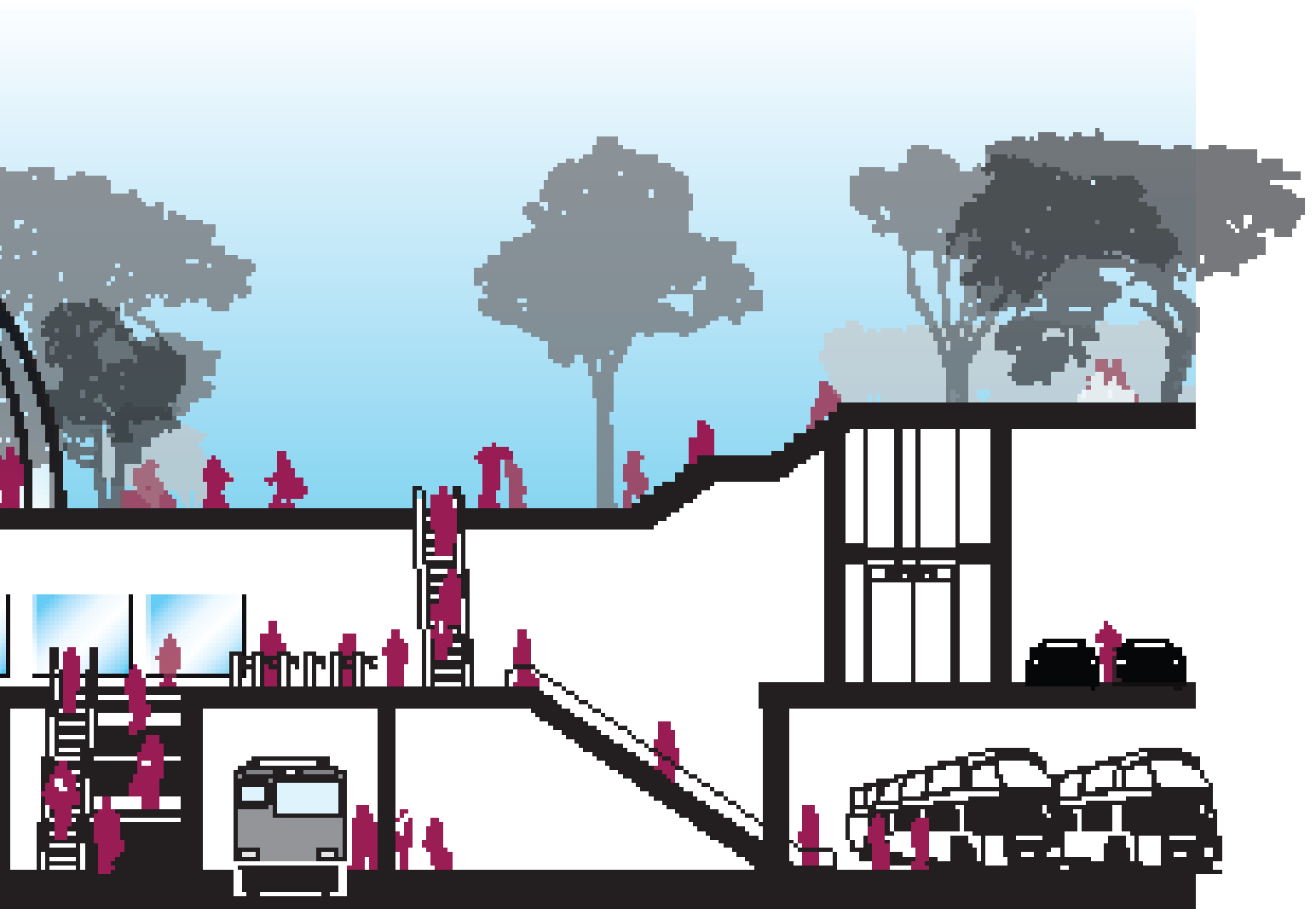

## 4.5 Recommendations for Information and Communication Technologies (ICT).

ICT applications, equipments and tools consume energy when i) being directly used by people and ii) while on stand-by (keeping ready for next use), no matter how “smart” the equipments and their networks are. Those consumptions are, for the moment, skyrocketing year after year in that part of the world that is “connected” (IEA 2014).

At the same time, public transportation operators are eager to offer their customers convenient and cool services delivered via ICT, and are also increasingly relying on ICT to manage, to surveil, track, monitor, control and conduct their assets (facilities, vehicles, staff, customers), and sell tickets.

This represents a tide of i) progressive centralisation, ii) increasing remoteness of the control hubs, and iii) expansion of undermanned/unstaffed services on the traveller's proximity. The traveller is progressively alone but permanently and wirelessly connected. If on the one hand this trend encourages the possibility to raise the attractiveness of public transportation (and stations), on the other it elicits the overall power consumption and opens the way to technology euphoria and the suppression of the benefits of direct human assistance to passengers. The following recommendations are proposed for the role of ICT in stations:

- Carefully review the usefulness of all non-essential ICT enterprises within the station. The net benefits of some ICT endeavours might be offset if all social effects, energy consumption, redundancy requirements and maintenance requirements (along their expected lifecycle) are considered.
- Implement only those ICT solutions that exhibit a sensible net benefit for i) the attractiveness of the stations or for ii) the reduction of its environmental footprint, iii) security and surveillance.
- integrate camera based security system fully into the station design and operation.

## 4.6 Recommendations for food storage and processing;

Medium and large stations are prone to include shops and restaurant-like shops that need to store or transform food and food products and allow for waste removal e.g. cooking oil, organic waste etc.. Preservation in cooled cabinets and cooking operations consume energy, produce noise (fans, compressors) might emit smells, smoke and steam, and produce waste heat (fridge's radiators, cookers ovens, boilers). To mitigate the (if any) detrimental effects of waste heat on the climatisation of the station:

- The location of the cooling and/or cooking equipments should be designed to efficiently remove the exhaust of the unwanted heat and to avoid its transmission to other nearby building parts.

## 4.7 Recommendations for water pumping.

The transport of water along pipes can conventionally be achieved either i) by the pressure provided by the distribution grid, ii) by the force of gravity (run-off) or iii) by the use of private electrically-powered pumps. To reduce the need of pumps that encumber on the operational energy demand and on maintenance requirements, designers should:

- Locate the toilets, showers and kitchens at levels that a) are serviced by the inner pressure of the grid or force of gravity and b) are above sewage main drains.
- Avoid the implementation of fountains, tanks or water curtains for decorative use only (fountains, pools and curtains that are part of passive climatisation designs are exempt)
- Provide appropriate drainage facilities to:
  - filter grey water to acceptable standards and
  - avoid blending grey and rain water
  - Minimize the use of pumps by using larger diameter pipes and reducing right-angle bends as much as possible

## 4.8 Recommendations for maintenance and keep-up tasks.

The design-for-maintainability approach (the design developed to facilitate the inspection, cleaning and swift replacing of damaged/defective parts) reduces the daily energy demand of the station. The intensity and frequency of the cleaning operations greatly (but not only) depends of the fouling- accumulation-rate of the station's micro-environments. The choice of materials, shapes and relative locations of items that form micro-environments influence the deposit and dispersion of debris and dust, but, at the same time, determine the encumbrance level of the cleaning tasks. The same applies to the repair or replacement of damaged elements of the station. The design of stations should privilege solutions that facilitate the maintainability of the premises, namely:

- Enabling physical environments and their components that avoid most of the maintenance operations with heavy machinery or high energy consumption. This means: to foster low energy maintenance made with the tools that can be swiftly mobilised and/or replaced.
- Enabling physical environments and their components that visually accommodate tenuous and safe levels of debris and dust without requiring immediate cleaning action (i.e. light fouling camouflage).
- Shaping the station components and accesses in order to enable easy removal of any improper element by authorised personnel (in case of accident, wear out, malfunction, broken parts, or scheduled maintenance). The replacement component, permanent or temporary, should also be easy to install or, if there is no replacement component to install, the absence of the original one should be as unnoticeable as possible. Easy, here, means, low energy demanding.

*Kandy station - Sri Lanka*





*Atocha, Madrid.*

## 5. Design for low water use.

### 5.1 Recommendations for the use of water by the station.

Stations, just like any other building, imply water consumption along their life cycle. The overall water consumed by a station should be divided into three different categories:

- **Embodied water** (the water demand incurred by the manufacturing and application of the building materials used to materialise the station premises, also named “the water embodied in the materials”),
- **Operational water** (the water directly and daily used to operate the station),
- **Transport water** (the water consumed by the transportation of occupants/users of the building occupants/users)

### 5.2 Recommendations concerning the embodied water.

Embodied water comprehends two sub-categories: i) the initial embodied water (the water incorporated in the original production of the station), and the ii) recurrent embodied water (the water incorporated by the refurbishment and retrofitting along the lifecycle of the station).

The initial embodied water is a fixed volume of water that is a consequence of the choices made by the designers about which materials and technologies to use on the construction of the station. The recurrent embodied water is a consequence of the number and extension of the renovation works needed for a given lifespan.

Three recommendations can be drawn from this:

- Design solutions with lower embodied water demand, should be favoured over more demanding alternatives,
- The durability of all competing design alternatives should be evaluated; sometimes the less water demanding solution might have a shorter lifespan than a more water intensive one. In this respect, it is noteworthy water also has a carbon footprint and should be considered accordingly.
- The original design of the station should facilitate eventual retrofitting or refurbishment works along the station's lifespan. The original design should incorporate "openness" to future modifications on the station (both programmed or reactive) in order to mitigate the pileup effect of successive destruction-construction cycles on the embodied water demand.

## 5.3 Recommendations concerning the operational water.

Operational water is commonly categorised as  
i) drinkable or potable water and  
ii) non-drinkable water.

The daily or annual consumption of operational water depends on the lifestyle and cultural habits of the station users, the availability, quality and cost of water, the number of station users and the efficiency of pipes and water fixtures.

Every day a bit more operational water is added to the stations' overall operational water bill.

It's an ever growing volume that expands along the station's lifecycle. The longer the station's useful life, the more important the efficiency of the operational water use becomes.

Most of the policies developed to reduce the water consumption in buildings aim at the use of operational water only.

A significant part of the drinkable water made available in stations is the result of man-made work: cleaning, storing, pumping and transporting natural occurring water. Piped drinkable water is "artificially produced".

This requires infrastructure (pipes, dams, holes, waterworks stations), energy, consumables (filters, additives, chemicals, spare parts) and constant maintenance and repair works. The production of drinkable water made available on pipes and tanks on most of the urbanised areas requires indirect CO<sub>2</sub> emissions.

Fresh water is a resource at risk in the coming decades due to high human consumption (including agriculture), high contamination of the natural sources, climate change and human-induced imbalances in the water cycle.

To attenuate the effects of this scarcity all modern human uses of water should be assessed and reshaped in order to decrease, where viable, the global water consumption. Most of the time it requires the reduction of drinkable water demand but it might also involve total or partial replacement of drinkable-water by non-drinkable water (less CO<sub>2</sub> costly) for non-drinking uses.

It is also wise to increase the number of times that a single portion of water is used before it is discarded in nature.

In stations drinkable water is commonly used to:

- Drinking and food processing
- Clean the built parts,
- Sanitation (operating and cleaning the toilets)
- Clean vehicles or other mechanical apparatus,
- Decoration and/or climatisation (in fountains, water curtains and water surfaces)
- Irrigation or watering of the station vegetation
- Emergencies (fire fighting, pollutant dispersion/ collection after spillage)
- Transport of sewage (from the building towards septic tanks or sewers or waste water treatment plants)

The smaller and simpler forms of stations (i.e. flagpole in the street, bus shelter, taxi stand) consume almost no drinkable water per year; they might be washed once or twice on dusty locations only and all the rest is taken care of by rain showers. Even railway unstaffed halts/stations might have scarce, if any, consumption of water per year as long as there are no toilets to operate, no staff to keep hydrated and most of the floor space is outdoors.

Only medium to large and staffed interchanges are net and practical consumers of treated water. We estimate that drinkable water makes the gross share of the water used in stations and, thus, an assessment of its necessity and efficiency should be incorporated early in the design phases.

We also consider that some medium and large stations may, where viable and by design, be equipped to work as rain water collectors.

We present some recommendations that aim at the mitigation of the drinkable water consumed per year per station:

- Limit the use of drinkable water. Drinkable water should be reserved to drinking, food processing and body cleaning only, if local legislation and safety & health precautions allow.
- Re-use as cleaning water. The cleaning of the built parts of the stations and the cleaning of vehicles should be designed in order to be completed with the smallest possible amount of water, ideally with non-drinkable water re-used as many times as possible (the different technologies that enable such re-use are nowadays mature and regularly used in the automobile-wash sector).
- Design to mitigate water losses due to wash. Buildings and their parts should be designed with the use of washing water in mind; glassed surfaces or other intense clean-demanding surfaces should be easily reachable by cleaning staff in order to reduce the need to use hoses or powerful water jets from apart (solutions prone to water spill); used water collectors should be located where needed; surfaces that do not require constant cleaning to keep a decent look are preferable to those where dirt is easy to accumulate or spot.
- In-situ collection of rain water. Whenever sustainable, station buildings should be designed to incorporate the details needed to collect the rainwater that falls within its perimeter. Those details comprehend the piping and the storage cisterns necessary to preserve the collected water free of water-borne pathogens. Eventually the collected water might be delivered to a communal/municipal storage tank/dam. The rain water might be used to water the vegetation in the station, to clean the building parts, to operate the toilets and to transport sewage. It is reasonable to expect that only in medium to large stations with enough room to host cisterns and in locations with considerable rainfall levels this type of water

*Hong Kong has an extensive dual water supply system that provides fresh water for potable uses and roughly filtered seawater for toilet flushing for homes, commercial and industrial buildings. The Hong Kong International Airport has its proprietary system to collect and use seawater for toilet flushing and for air-conditioned cooling*

collection becomes sustainable.

Last but not least, water cooled chillers must be regularly cleaned to avoid infectious diseases such as legionnaires' illness.

- Grey water re-use. The possibility to use the stations grey water (the wastewater from hand-washing sinks and showers) to flush toilets should be examined. This adds one extra use to the wastewater before it is discarded. The design of the buildings with such a reuse capability (limited by law in some jurisdictions) should: 1) minimise the need of pumps to elevate the grey water (most of the conventional sewage grids work on gravity only) for the tanks that feed toilets, 2) consider that grey water has a different viscosity and greasiness than drinkable water and might need to be filtered and UV- treated to achieve acceptable quality (Santos et al 2012), 3) the need of extra ventilation or de-odour mechanisms, 4) the need to redesign cleaning operations of the toilets.
- Seawater use. In locations close to the seacoast the extraction of seawater for toilet flushing should be evaluated. The use of seawater for toilet flushing is common in ships but is also mature (although not common) in urban areas. The introduction of seawater in the sewage system requires fine tuning with the sewage treatment stations once their chemical processes (if designed for fresh water) might be affected by the seawater composition. The transport and use of seawater usually requires fixtures and pipes sturdier than the ones prepared for freshwater.
- Location of toilets, showers and kitchens to reduce the CO<sub>2</sub> and energy cost of sanitation. Water demanding rooms should, if possible, be located in floors that minimise or eliminate the need of pumps to elevate water or sewage (very high or deep underground locations should be avoided). Abundant passive natural ventilation should be provided in order to turn electrically driven air extraction unnecessary.



- Design of the toilets and showers to reduce leakages and wasted water. The public access facilities like toilets and showers (both for the public or for staff) should be designed in a “sectorised” manner that enables the swift isolation of any single defective part of the plumbing without jeopardising the operations of the remaining installation. Efficient fixtures (e.g. taps, valves, showers, flush cisterns, flush valves) should be adopted. Public toilets and showers should be designed in a robust manner, should be staffed and tightly inspected to detect, as soon as possible, the faintest signs of malfunction, soil or fouling. Those facilities should be designed for maintainability, for security and to mitigate the soiling snowballing effect. Good looking, well maintained and reliable toilets contribute also to the stations attractiveness. The design of decent public toilets is not the mere replication of simpler and hardened versions of their domestic equivalents.
- Rainwater as an aid. Rainwater and flood water transport sediments and debris along its flow on the ground. Building details and pavements should be designed in order to eliminate the need to wash the sediments and debris left by usual rainfall or recurrent floods. The natural flow of water should deposit the unwanted material away from the functional parts of the station and away from the path of the pedestrians. In short: design in order to turn rainwater into an effective cleaning agent of the premises.
- Incorporation of fountains, water curtains or water surfaces. Those types of design solutions should be adopted only if they are integrated in a broader bio-climatic climatisation scheme. The evaporation of water droplets can be used to effectively cool the environment, indoors or outdoors, but the recirculation and treatment of water requires energy and continuous maintenance. Fountains, water curtains and water surfaces with decorative purposes only should be avoided.
- Free (to users) drinking fountains. Stations in relatively isolated or warm locations should be provided with enough drinking fountains. Under warm environments, well hydrated individuals can stand higher temperatures than thirsty ones – the threshold of discomfort is higher for well hydrated individuals than for thirsty ones. The provision of easy to obtain and reliable drinkable water might lessen the cooling requirements of some station areas.

## 5.4 Recommendations concerning transport water.

Transport water demand is mostly an indirect water demand. The mobility of the station users requires different modes of transport and the production of this transport consumes water. The operation of vehicles directly consumes a minor amount of water for cleaning the vehicles, refrigerate their engines or wash their windscreens.

A large use of water is for the maintenance and cleaning of the vehicles. Depot facilities would need to be designed accordingly. This is not difficult but needs a careful design strategy - central or operational based treatment, or both. But it also consumes indirectly a huge volume of water that was used to produce and deliver fuel and energy, and to perform its maintenance. Its commonly assumed that, for a car, the indirect transport water amounts for 98% of their overall transport water consumed in one year by the operator<sup>9</sup>.

Transport water demand grows with the increase of the Km travelled per year, and directly depends on the “indirect water intensity” of each particular transport mode. From the strict economic point of view the transport water demand can be allocated to the buildings that motivate peoples mobility; either their homes, their workplaces, their schools or their social venues. This suggests that a reasonable way to reduce the total amount of transport water consumed by a given community is to:

- Keep to a minimum the travelled Km on engine-powered vehicles, which means to foster walking and cycling by land-use-planning and public space design,
- Increase the public transportation share on the community’s mobility, which means to make public modes attractive to people.

<sup>9</sup> Estimations point for: 98% due to the fuel production, fuel distribution and car maintenance operations; and 2% due to car cleaning and engine refrigeration.



Oporto - Portugal

## 6. Design to decrease CO2 emissions.

### 6.1 Recommendations concerning the CO2 footprint of the station.

Just like any other built structure, stations carry a CO2 footprint due to its creation and use. Conventionally the CO2 emitted to produce and operate any building is divided into:

- Embodied CO2 emission (also called capital carbon); is the amount of CO2 emitted to extract the raw materials and resources, to transport, process, manufacture, assembly, install, preserve and dispose the materials needed to materialise a station.

- Operational CO2 emission, is the amount of CO2 emitted to perform the station daily operations. This might include direct emission (e.g. burning fuel at the station's electricity generator or central heating boiler) and/or an indirect emission (e.g. the CO2 emitted by far away powerstations to produce the electricity mix purchased by the station manager).

Depending on the lifespan and automation level of a building, the operational emission might amount to 70-80% of the overall footprint (Gieseckam et al 2014).

The calculation of the CO2 footprint of materials, products or buildings only recently began to be defined in a standardised manner. The most commonly accepted standards for this purpose are, currently, the BSI-PAS 2050 (2008) and the ISO 14067 (2013).

## 6.2 Recommendations on the material-embodied-CO<sub>2</sub> of the station.

All building materials and components used to produce a station, from the door handle to the roof of the station, have a specific CO<sub>2</sub> footprint. This footprint is called “material-embodied CO<sub>2</sub>” of a given material and represents the CO<sub>2</sub> emitted to produce that particular material. Material-embodied CO<sub>2</sub> results from the sum of:

- The initial embodied CO<sub>2</sub> (the CO<sub>2</sub> emitted during the extraction, refining and manufacture of the material),
- The transport-related embodied CO<sub>2</sub> (the CO<sub>2</sub> emitted to transport the material up to the construction site of the station),
- The transformation-related embodied CO<sub>2</sub> (the CO<sub>2</sub> emitted during the transformation/shaping of the material to adapt it to the station),
- The maintenance-related embodied CO<sub>2</sub> (the CO<sub>2</sub> emitted by the maintenance or upkeep of the material after application in order to safeguard a decent service life),
- The disposal-related embodied CO<sub>2</sub> (the CO<sub>2</sub> emitted by the disposal operations of the material at the end of its service life, regardless of the type of disposal<sup>10</sup>).

The sum of the “material-embodied CO<sub>2</sub>” of all physical components of a station represents the “station’s embodied CO<sub>2</sub>”.

It is clear that the material-embodied CO<sub>2</sub> level is unique to each material source. More precisely, two pieces of the same size and weight of the same grade of steel from two different manufacturers, have two different material-embodied CO<sub>2</sub> levels. Each supply chain emits its idiosyncratic amount of CO<sub>2</sub> to deliver its products.

It is also reasonable to admit that the chosen maintenance and upkeep procedures affect the embodied CO<sub>2</sub>. A more relaxed or light procedure might emit less CO<sub>2</sub> than a tighter or more careful one. No-cleaning and no-maintenance are less CO<sub>2</sub> demanding than cleaning and maintaining. The downturn is that no-cleaning & no-maintenance policies usually shorten the service life of the station parts and constrict its overall attractiveness.

The difficulty of dismantling part of the station to forward it for disposal also likely influences the total amount of embodied CO<sub>2</sub>, just like the transportation mode used to carry that part to the construction site at the beginning of its service life. A complete calculation of the material-embodied CO<sub>2</sub> requires a deep knowledge of the particularities of the station design, life-span and disposal conditions of all the station parts. Given that this exhaustive knowledge is seldomly available to the designers, the selection of the materials is often guided by generic directives, estimates, forecasts, gross simulations, guesswork and rule of thumb. We should keep in mind that the selection of materials and the design of the station parts is not only driven by the assessment of the embodied CO<sub>2</sub> of alternative materials.

The selection of the materials and the design of the shapes given to the materials is also oriented by i) the intended durability of the station parts, ii) their use and purposes, iii) their look and cost, iv) the access to the technologies required to transform and install, v) the local weather and the vi) intended maintainability.

On top of all those considerations, the designers should also keep in mind that there is a CO<sub>2</sub> emission derived from the (possible) refurbishment operations along the station’s lifecycle. The technology required and the energy spent to refurbish a given part of the station to a large extent also depends on the design, materials and assembly methods used in the original construction.

The precise calculation of the embodied CO<sub>2</sub> of materials is a delicate task that often collides with a) lack of reliable information disclosed by the manufacturers and/or retailers, and almost always with b) lack of information about the intended lifecycle of the station. Practical approximations to those values might be found in the work of different authors (e.g.: Jones 2011, Roman and Agnes 2006), and some of those values are shown aggregated with the energy embodied on the different materials.

In general terms, if two alternative materials are produced with the same technology and process:

- The material that travels most from the manufacturing site to the construction site has more CO<sub>2</sub> embodied,
- The material that consumes more energy to produce has more CO<sub>2</sub> embodied,

<sup>10</sup> Disposal includes: reuse, recycling, conversion to thermal energy or deposition in landfill.

- The material that requires more processing has more CO2 embodied,
- The material that incorporates more recycled filling/ingredients for its manufacture has less CO2 embodied.

Sounds cautions to consider that, currently, a public transportation station can hardly achieve the category of “carbon-neutral building”.

But the design choices can deeply affect the final amount of embodied CO2. Theoretically, the selection of the appropriate building materials can reduce around 40-45% of the CO2 emissions assignable to construction and reduce up to 50% of the embodied energy of a building. Even if empiric evidence comes to suggest that design choices can generate reductions half that big, then, the role of design professionals is not of secondary importance at all.

The design recommendations that we draw from the consideration of the material-embodied-CO2 of the stations are:

- Select materials with the lowest possible embodied CO2 and with an expected service life not much longer than the planned service life of the station,
- Favour materials that enable a good ratio investment cost/ operational cost for the station,
- Adopt materials that are positive contributions to the station attractiveness along its lifecycle,
- Prefer materials with mature disposal technologies available (e.g.: nowadays most metal alloys are easy to recycle if used non-combined with other materials; concrete and masonry can be crushed to be used as aggregate on road building, on general bulk fills, drainage structures, foundation fills or on bituminous concrete. Substitution fuels (also called biomass-derived fuels) are surplus resources (plastics, wood and vegetable waste, methane collected from landfills or reactors, used oils, paper sludge, textiles, etc) that can be turned into feedstock replacing virgin fuels and, at the same time, minimizing landfill waste.
- Prefer materials with disposal technologies that are not high energy/CO2 demanding or which final result has some practical use,

*The longevity of buildings implies that many of the buildings which are currently in use will still be used for a number of decades. In the United Kingdom, for example, ‘up to 75% of the dwellings of the year 2050 already exist now’*

- Select materials and design assemblies and shapes that facilitate i) maintenance, ii) repair and iii) disassemble for disposal,
- Combine materials and design building parts to mitigate decay or early aging signs, namely those derived from current maintenance or use; there is no use of selecting low-carbon materials if they can’t stand the station’s erosive environment.
- Favour alternative materials whenever possible. Materials, that are alternatives to the conventional and environmentally demanding steel, concrete and masonry, can be prescribed both for structural and non-structural elements, depending on local weather stresses and availability. Among those: timber and transformed timber (e.g. brettstapel, OSB boards, laminated elements), straw-bale, earth (e.g. rammed earth, adobe, bricks, etc), hemp aggregates, lime aggregates, etc. Those have negligible embodied CO2.
- Favour materials with substitution ingredients on their composition<sup>11</sup>.

- Favour materials produced with substitution fuels on their manufacturing process<sup>12</sup>.

- Optimise design and manufacturing processes to reduce excess material, over-dimensioned elements and manufacture waste. Manufacturing processes located off-site

(in dedicated factory or workshop) produce less waste than the usual 10-15% of in-site manufacture. More design effort (work) can produce more streamlined components, with smaller overall mass.



London, St. Pancras

<sup>11</sup> Substitution ingredients are non-virgin materials or substances obtained from the recycling or waste of other products and industrial processes (e.g. fly ash, vegetal waste, sewage sludge ash, paper sludge, carpets and textile waste, plastics, waste timber, glass. Ceramics, demolition waste, etc). The use of substitution ingredients causes a reduction on the embodied CO2 of the resulting materials.

<sup>12</sup> Substitution fuels (also called waste-derived fuels) are waste materials (plastics, wood and vegetable waste, methane collected from landfills or reactors, used oils, paper sludge, textiles, etc) that can be burned to replace the consumption of virgin fuel and, at the same time, reduce the volume of landfill deposition of waste.

- Design in order to increase the amount of building elements that can be dismantled and re-used on refurbishments along the stations lifecycle<sup>13</sup>. This strategy may require the development of label/traceability solutions to identify the most valuable components to re-use and their mechanical characteristics.
- Incorporate the principles of adaptable design; designs that allow for the future expansion or transformation of the station with minimal possible energy and CO2 expenditure.

*In Germany, more than one quarter of final energy consumption is devoted to space heating*

amount of CO2 captured by concrete elements along a stations lifecycle tends to be negligible.

- Favour refurbishment of existing premises instead of demolition and new construction whenever viable. Most of the times, old buildings can be refurbished and upgraded to achieve the same thermal, energy and safety performance as new ones, with a sensible embodied CO2 net advantage over the alternative of demolition-plus-new-building. The embodied CO2 of existing buildings can not be deleted and its profitability should be maximised. The “to-be-embodied” CO2 of forthcoming buildings should be avoided as much as possible. It therefore seems reasonable to assume that the annexation of newly built areas to an old building (in order to expand its capacity) is wiser than the decommissioning of the old building and the erection of a brand new autonomous full capacity building. The far reaching social, economic and environmental benefits that favour refurbishment over demolition on the home sector (Power 2008) apply also to the public transportation sector.



Berlin, Germany

- Be very cautious about the trend to use concrete in buildings as a CO2 sequestration agent. The carbonisation of concrete (a naturally occurring chemical reaction on air-exposed concrete) captures and stores atmospheric CO2 but at a very slow rate and, in practical terms, under very particular environmental conditions (Borjesson and Gustavsson 2000). The total

## 6.3 Recommendations for operational CO2 emission.

The direct and indirect emissions derived from the station's routine operation greatly depends on i) the level of automation of the station, ii) on the energy demands for climatisation, and iii) the energy demands for lighting.

From those principles, several recommendations can be drawn:

- Prefer passive or non-mechanised design solutions over mechanised ones. Whenever possible keep to a minimum the use of automatic doors and gates, lifts and escalators, blinds or shutters, ticket inspection/control devices, fans, air extractors, etc. Human-powered solutions (when feasible) mitigate the energy and maintenance demands and open an opportunity to humanise the environment and provide staff vigilance (SPINUP, 2007).
- Favourable natural passive or highly efficient climatisation solutions (this might require extra insulation that adds on the embodied-CO2 bill).
- Promote robust lighting designs that:
  - i) maximise natural lighting intake,
  - ii) make efficient use of illuminance and reflectivity,
  - iii) produce comfort and visibility without jeopardising climatisation,
  - iv) mitigate permanent supplementary artificial lighting and light pollution.
- Favour the purchase of electricity from the supplier with the “greenest” offer. Currently, most suppliers must include electricity from fossil fuelled powerplants on their

<sup>13</sup> Re--use of building parts was common in ancient construction; elements collected from buildings that were demolished (wars, accidents, end of service life) were re--incorporated in new constructions. This comprehended both structural, cladding, decorative elements and fittings like doors and windows. Much of our present architectural and cultural historical heritage is made with re--used building parts.

commercial offer in order to ensure continuity of the supply. The electricity mix offered to customers might have a lighter or heavier share of fossil fuels on their production. If alternatives exists, choose the mix with the lightest share of fossil fuels.

- Optimise the overall electricity requirements of the station.  
Review all the “hidden” power demands due to IT applications, equipments or devices added after the station commissioning. Battery powered devices have a less efficient power use than plugged equivalents. ICT applications, entertainment equipment, air conditioning machinery and radio transmitting devices can build up a significant but “invisible” electricity demand. Evaluate the possibility to modulate or regulate the electricity demand according to the time of the day or passenger flow. Mitigate futile use of energy.  
Monitor power usage achieving a high degree of granulation of data (smart metering of systems and sub-systems).

## 6.4 Waste collection systems.

Stations generate a relevant amount of waste that must be discarded from the premises. In reality the waste volumes from station operation in themselves are small. It would be best use of the station facility to have each facility be responsible for getting rid of their own trash. If the station becomes a central point for recycling then a different scale of management will be needed if this should not effect station operations.

This is the waste produced by i) passengers while on the station or while approaching the station; 2) the small parcels (including newspapers and magazines )of rubbish that are deposited on the stations trash-bins and 3) the larger garbage parcels produced by the stations shops and restaurants (if any) that are deposited in larger containers. The design of the station can reduce the CO<sub>2</sub> and energy footprint of the premises if:

- Space and containers are provided to materialise a selective waste collection system; a system that offers segregated containers for de deposition of different types of waste by the

station users and shopkeepers<sup>14</sup>. For safety and security reasons, fire security may pre-clude this room.

- “Backstage room” is provided to compact and store the collected waste until it is evacuated from the premises, without dissipating unpleasant smells (organic waste might require cooling or other stabilisation technique).

The station should only be equipped with the hardware for a selective waste collection system if a supply-chain as such can cover all or some of the station in the network. Pretending to be part of selective collection system and re-mixing the collected waste on the backstage of the station (because there is no selective collection-chain downstream at all) is a risky and counterproductive precedent.

Materials like metals, glass and paper, if collected separately, can be forwarded to recycling units.

Some plastic can be forwarded for recycling and a significant part can be burnt as substitute fuel for electricity production. Dense organic waste (food waste gathered in large amounts from restaurants only) can be directed to land-fill deposition or to bio-chemical induced decomposition to produce methane (a substitution fuel for electricity production in small to medium electric power plants).

To be safe and economically operative, the facilities needed to extract methane from food waste must be of industrial-size and significantly pollutant and, thus, unacceptable within the urban environment. The vicinity of the stations should, whenever possible, be exempt of such facilities.

Methane can be bought and used as a substitution fuel on the stations generators (if any and if prepared to burn methane). The use of methane in stations still has two relevant drawbacks: a) piped methane distribution is uncommon, b) methane storage tanks are cumbersome for many urban locations.

*At the Biogas station at Matale District Hospital food waste is converted in methane used for cooking in the hospital*



Biogas station at Matale District Hospital - Sri Lanka

# 7. Design for better public health.

If very little about the impact of transit, urban planning, denser land-use and built environment on public health has been documented, many mobility and public health professionals have been convinced that improving urban design and built environment can encourage people to walk more for functional purposes rather than for leisure purposes only.

In this chapter we will elaborate on the link between mobility, urban planning and public health.

Considering 1. the rise of obesity, high blood pressure, high blood cholesterol, asthma and cardio vascular diseases including in developing countries, and considering 2. obesity and diabetes are reported to be the highest public health risks in developed countries as well as becoming a heavy burden on public health expenditure, considering 3. as research has pointed out an inverse, though not causal, association between active transportation and obesity rates, we believe a higher willingness to integrate walking or cycling is one's daily activities in order to bring about a behavioural paradigm shift to active transportation may be examined. We therefore also focus on mobility and city planning from a public health perspective.

Research has pointed out that in developed countries less education and lower income are generally associated with obesity. In this respect we refer to obesity and overweight underlying chronic diseases such as high blood pressure, diabetes, types of cancer, lack of energy and cardio-vascular diseases. Therefore the need for active communication supported by a legislative framework (in line with the EU Charter on Fighting Obesity (Istanbul, November 17th, 2006) on the impact of active travel on public health, seems highly recommendable.

Communication campaigns can focus on the link between healthy food habits and on more physical activity. Their messages will be understood and adopted if corroborated by fact and figures.

Statistics obtained through the monitoring of active travel at different health-enhancing thresholds and the identification of trip purposes that contributed to health, using transport survey data., could be an instrument to promote synergies between health practitioners and public transport operators.

Similar research (Dafna Merom, Hidde van der Ploeg et al.) carried out with the help of transport operators, has demonstrated significant increases for all walking indicators, even health enhancing walking increased for most population subgroups. It was concluded therefore that transportation surveys can be used to assess the contribution of active travel to changes in physical activity levels assessed by public health surveillance and to identify subgroups for active travel interventions. This type of research however is insufficient as with public health measurement and might result in a misleading picture.

Even though the study demonstrated the utility of transportation data collection, for public health purposes and considering the fact that walking and cycling trips to the station can influence reporting of transportation trips, it needs to be confirmed that in most countries today walking and cycling are not considered priority modes. It is therefore also important to adopt multi-faceted pro-bicycle policies complemented by an integrated set of community wide interventions.



Ghent, St. Pieter - Belgium

Looking into the contribution of active travel to and from school to children's overall activity levels in England it was demonstrated that 6% of the children who walked and 3% of the children who cycled were more active than the 33% who did neither. It was recognised however that in time more research is still required to ascertain that active travel also affects less active children.

The synergetic positive effect of active transportation on public health seems however beyond doubt. As a consequence there is an implicit need to link transportation planning and public health. What can transportation - and urban - planners do to address the issue? How can a comprehensive regional planning process influence urban form requiring municipalities to comply with specific regional growth principles in order to receive prioritisation for their desired transportation

infrastructure projects, ie including quality land-use projects.

In this respect we can observe that in the US the vast majority of transportation funding ie in excess of 95% is spent on infrastructure and road projects, also

that a transportation system that vastly depends on one or two modes is more susceptible to disruption and system failure than one that is multi-modal (Knoxville 2002). In line with these recommendations focusing on the activation of travel, on modal interconnectivity, safe bicycle lanes and walkable communities, we do not need to stress further the need to link of mobility planning, urban planning for the benefit of quality of public health and quality of life of citizens in general.

Amir Samimi and Abolfazi Kouros Mohammadian examined the role of transportation, land-use and the built environment variables. They used them to develop probit models for predicting health related variables. Six binary variables for public health (obesity, high blood pressure, high blood cholesterol, asthma and cardio vascular diseases) were defined and the associated binary probit models were reported. In addition to car use, transit use, block size and road density were influential on the health of people. Their research specifically demonstrated that increasing transit use and decreasing auto use have a significant positive

impact on all health variables except for asthma. It was further suggested that in pedestrian friendly neighbourhoods people walk more and adopt healthier life styles.

In conclusion and in addition to Transit Oriented Development the facilitation of Pedestrian Oriented environments could motivate people to be more physically active in their daily routine, enjoy a healthier life and this consequently could relieve the burden of medical expenses.

### 7.1 Active travel and gender

In the field of active travel and gender, a series of objectively measured attributes have been identified that influence physical activity levels in older women and indicates low neighbourhood Socio Economic Status (SES), urban form and proximity to business and facilities as key influencers. In

terms of neighbourhood SES it can be suggested that positively perceived security, safety, the availability of well maintained benches, green areas, good lighting, overall aesthetics, signage and way-finding may improve physical activity levels in several population

groups specifically on the physical activity levels of older women.

*There is little use of having a bus line to a residential area inhabited by young people ending at 8pm.*

*The same applies for a tram line that does not allow for people to return home after a social venue, or that does not run on weekends.*



## 7.2 GENERAL RECOMMENDATIONS

- Equip Transportation Authorities with Public Health and Environment experts
- Develop public health oriented transportation policy
- Develop pedestrian oriented walkable neighbourhoods
- Promote mixed land-use as it generates shorter trips
- Allow for small plotting of retail zones
- Promote walkable block size
- Restrict car-use designing car-free zones, low speed zones, no through traffic zones
- Interconnect travel modes through transit hubs
- Promote pedestrian accessible urban retail and services cores
- Prioritise pedestrians and cyclists over motorists in traffic regulations and enforcement policies
- Impose high cost for owning and driving a car
- In transit hubs and retail cores stipulate minimum percentage of availability of locally sourced products and services. Furthermore, at the very station level it is suggested to consider specific recommendations covering the actual human programming of the station environment. To this end it is advisable to initiate and maintain positive regular dialogue with vital stakeholders including but not limited to:
  - representative of shop-owners, small and big business owners
  - representatives/owners of other modes of transit (taxis, busses, etc)
  - school principals
  - hospital management
  - market vendors
  - event organisers
  - police
  - municipal authorities
  - hobby clubs

Research has demonstrated that in order to create a lively environment throughout different times of the day, week and year it is important to allow for multi-functional use of the space ie diverse occupation and use. The diversity of occupation and use will prevent that at specific times of the day (24h) the space is desolate or abandoned and inspire fear to occasional passers-by.

Moreover, multi-functionality will also generate a diversity of traveled distance and therefore stimulate differentiation of the expectations and demand. Concept-wise the multi-functionality of a station depends on its complexity of organisation or its hierarchical status comparable to the hierarchy of a city.



Stockholm - Sweden

# SPIN UP: the combination of culture, complexity, context and community-oriented leadership.

## 1. Culture and complexity.

Antwerp is not Mumbai, Caracas is not Moscow, Paris is not Shanghai, New York is not London. Likewise we can refer to stations. As with cities, the attractiveness, quality and kind of a station is defined by its complexity, by the number and different modal connections, the distance of its connections, the complexity of its organisation and facilities and the quality of its services.

An interchange with High Speed and airport connection will attract a different audience than an interchange with only urban and regional connections.

High Speed and airline passengers are likely to have a different time frame in front of them than an underground traveler whose next train is in 90seconds. Facilities and services need to be adapted to these practical travelers' expectations.

Along the same lines, we have observed that the level of development of a station also depends the retail potential of the station, hence the possibility to generate non-rail income.



In practice the success of the programming of a station can be achieved through the programming of activities:

- foreseeable daily use: schools, businesses and offices
- commuters come in from varying places of origin come and go within tight time frames in one direction
- foreseeable (weekly/daily) use: markets, shops
- visitors come and go within larger time frames in both directions
- foreseeable seasonal use: fairs, events, festival
- visitors

Secondly, it is important to point out that even if modern public transportation networks use proprietary/semi public premises, they should be considered “Heterotopias” given users of all ranks, status, gender, social, ethnic, cultural, religious and intellectual backgrounds are welcome under the sole condition that they respect ‘the rules of the game.’ These ‘rules of the game’ imply, for example, that they pay for the journey and behave according to an explicit and implicit body of rules. No one group should dominate the space nor impose its own behaviour or rules upon other clients/staff present at any given time.



*Mumbai - Chhatrapati Shivaji Terminus*

The heterotopia (Michel Foucault, 'Of Other Spaces'/'Des Espaces Autres', 1967) concept allows for the fact that the nature and quality of each public space/urban public transport station is strongly influenced, if not defined by, the nature and quality of the surrounding neighbourhoods. In order to improve perceived security, it is important that stations serve beyond their functional status as a nodal point and adopt the status of a human interactivity platform.

The organisation of space in the Heterotopia:

### Front Space - Back Space

Likewise, this implies that infringements of these unwritten codes of conduct will not be tolerated. Therefore, prevention and dissuasive information prior to imposing repressive measures is crucial. The heterotopia status of the station also implies that users are to be considered as citizens and clients first, and consumers second, since not all clients are consumers.

The “Heterotopia” status diminishes the risk of tension and other accumulations of negative emotions. It also brings extra vitality to public transportation in a sustainable way.

As we equate a PT-station to a heterotopic public space, we come to the notion of front and back space behaviour.

Front space behaviour is defined as the behaviour that is expected in a public space and meets an explicit and implicit body of rules. This would include, for example, the way passengers use a seat, sitting on it as the designer intended.



Elaborating on this example, back space behaviour would mean the user uses the seat in an unexpected or even unwanted way. Back space behaviour can be defined as behaviour one would normally only reveal at home or in another private space, not in public.

## 2. USE RUSE ABUSE.

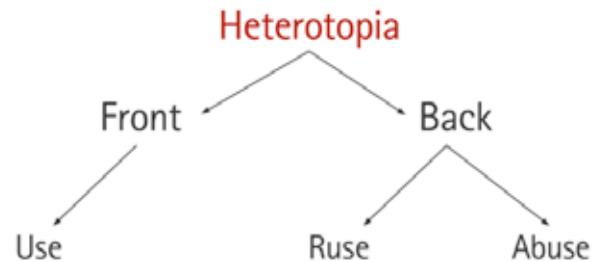

The heterotopia follows a code – formal or informal - of the accepted ways of using the network in use. But society evolves, as do codes-of-conduct and conventions.

What was impolite ‘ruse’ in the past might have become an acceptable or relevant way to behave today and a brand new behaviour might update another from the ruling code-of-conduct.

No matter the network, acceptable behaviour must be first circumscribed and made public before the PT operator can accept it and possibly allocate resources to enforce it.

It is recommended the design & human engineering to consider:

- fostering the “correct” use of the PT network and services, be transparent on what is “correct”
- avoiding unconventional forms of use of the PT premises by some passengers (ruse) becomes annoying and negative nuisances to others,
- dissuading abuse, make it easy to detect and to repair,
- enforcing the code-of-conduct ensuring a balanced mix of “educational” and a “repressive attitude” to avoid extra sources of stress.

### 3. Community-oriented leadership, the status of the operator as main actor:

#### **Mobility and Community services provider**

Independent of the heterotopia or hierarchical status of the semi-public space as described, PT-operators should position themselves as mobility and community services providers, i.e. as key actors in development of attractive cities. Indeed, PT networks are excellent tools that link neighbourhoods, help communicate and promote social cohesion. We expect them to drive us from here to there, inform us of incoming trains and buses and possibly also entertain us while we do some shopping in their premises surrounded by attractive music, art, lights, etc.

This position as mobility and community service provider can only be achieved as long as the PT actors excel as to deserve this status of respect and authority. In practice, this implies that the PT network is visible in the city, with clearly signposted entrances/exits and signage to and from the platforms, reliable timetables and performance information, premises, facilities and services that are kept clean and maintained in perfect working condition, staff that adopt a customer friendly attitude, a good combination of commercial and other services on hand... in short, that intuitively, we feel confident about the network and its operator.



Weststation - Brussels. STIB

Along with the client confidence comes their identification with the network. Encouraging clients to identify with the network can be promoted through a series of sensorial measures such as the integration of public art by local artists, references to activities in the surrounding neighbourhood (museums, music halls, universities, squares, etc.) clear signage, information and other forms of communication.

### 4. The practice of SPIN UP.

The above mentioned 3-fold theoretical concept to design public space and public transport space can be implemented in 3 levels of intervention:

- infrastructure
- equipment
- day-to-day operations

Yellow design Foundation's research findings confirm that perceived security in urban public transport cannot be satisfactorily addressed from a technical perspective only. It requires insight and understanding of the context, culture, social and economic dynamics of the environment and station surroundings along with an understanding of the mechanisms and emotional perceptions of users, passers-by, visitors, citizens at large.

SPIN-UP honours the principles of human interaction in the heterotopia and stresses the operator's position as mobility and community services provider. This methodology is currently applied by PT transport operators and specific consumer oriented businesses in Europe. SPIN-UP is praised for its impact leading to positive social and customer relations as well as maintaining, if not reducing, the cost of maintenance and equipment. Examples of recommendations are added in the annexes.

#### **References:**

*Almusaed, A., Biophilic and Bioclimatic Architecture, Springer-Verlag, London, UK, 2011*

*Borjesson, P. and Gustavsson, L., (2000), Greenhouse gas balances in building construction: wood versus concrete from life-cycle and forest land-use perspectives, Energy Policy, Vol.28.*

*BSI, (2008), PAS 2050-Public Available Specification no.2050; Specification for the assessment of the life cycle greenhouse gas emission of goods and services, British Standards Institution,*

Gartland, L., *Heat islands; understanding and mitigating heat in urban areas*, Earthscan, London, UK, 2008

Giesekam, J., Barrett, J., Taylor, P. and Owen, A., (2014) *The greenhouse gas emission and mitigation options for materials used in UK construction*, *Energy and buildings*, Vol.78

Hyde, R.(ed), *Bioclimatic housing; innovative designs for warm climates*, Earthscan, London, 2008

IEA (2014), *More data, less energy; making network standby more efficient in billions of connected devices*, International Energy Agency, Paris.

ISO (2013), *ISO14067; Greenhouse gases – carbon footprint of products – requirements and guidelines for quantification and communication*, International Organisation for Standardisation.

Izard, J, *Arquitectura bioclimática*, Gustavo Gili México, Ciudad Mexico, 1983

Jones, G., (2011), *Inventory of carbon & energy; ICE version 2.0*, SERT-University of Bath, UK.

Leung, R., Li, D., Yu, W., Chui, H., Lee, T., Van Loosdrecht, M. and Chen, G., (2012) *Integration of seawater and grey water reuse to maximise alternative water resource for coastal areas; the case of the Hong Kong International Airport*, *Water Science & Technology*, Vol. 65(3), pp.410-417

McCarthy, M., and Sanderson, M., *Urban Heat Islands: Sensitivity of Urban Temperatures to Climate Change and Heat Release; In Hoornweg, et al. 2011, Cities and climate change: responding to an urgent agenda - Main report*, *Urban development series*. Washington, DC: World Bank, USA, 2011

Olgay, V., *Design with climate; Bioclimatic approach to architectural regionalism*, Princeton Univ. Press, Princeton, USA, 1963

Power, A.,(2008), *Does demolition or refurbishment of old and inefficient home help to increase our environmental, social and economic viability?* *Energy Policy*, Vol.36.

Roman, J. and Agnes, S., (2006), *Towards carbon neutral and climate adapted domestic buildings*, Branz Ltd, Judgeford, N.Zealand.

Santos, C., Taveira-Pinto, F., Cheng, C. and Leite, D., (2011) *Development of an experimental system for greywater reuse*, *Desalination*, Vol.285, pp. 301-305

Stephan, A. and Crawford, R., (2014) *A comprehensive life cycle water analysis framework for residential buildings*, *Building Research & Information*, vol.42(6).

USEPA, *Reducing Urban Heat Islands: Compendium of Strategies*, US Environmental Protection Agency, Washington, USA, 2008

Ravetz, J., 2008. *State of the stock—what do we know about existing buildings and their future prospects?* *Energy Policy* 36 (12) 4462–4470.

Tzscheutschler P., Nickel, M., Wernicke, I., Buttermann, H.G., 2009. *Energieverbrauch in Deutschland*. *BWK* 61 (6), 6–14.

Siller, T., Kost, M., Imboden, D., 2007. *Long-term energy savings and greenhouse gas emission reductions in the Swiss residential sector*. *Energy Policy* 35 (1), 529–539.

Wilhelm Kuckshinrichs, Tobias Kronenberg n, Patrick Hansen *Forschungszentrum Jülich, D-52425 Jülich, Germany, The social return on investment in the energy efficiency of buildings in Germany*

About the trip road environments significance for walking, cycling, health and wellbeing  
Schantz, Peter 2012 (Swedish)

Peter Schantz  
Dr med sc, Professor, GIH - The Swedish School of Sport and Health Sciences, The Unit for Movement, Health & Environment

Physical activity in different time domains - changes over time. The environment can influence the behavior of physical activity  
Route Environments built up of segments with different environmental factors  
ACRES (The Active Commuting Route Environment Scale)

# Part II Land-use solutions

## 8. Introduction.

Land-use planning is defined by the World Bank as a “public policy exercise that designates and regulates the use of land in order to improve a community’s physical, economic, and social efficiency and well-being” (World Bank, 2010). This is one of the most general definitions of which the basic standard classification of land-use indicators stretches, according to the American Planning Association, across five dimensions: Activity, Function, Structure Type, Site Development Character, and Ownership.

For many policy makers, governmental officials and commercial developers involved in mobility, land-use is a term mainly associated with real-estate values, control and regulations. However, the successful land-use approach does not have only the controlling and policing function: it establishes a good link between the spatial planning, the spatial design and the instruments of control and legislation. The integration of these aspects of land-use form the core of more sustainable urban practices.

Land-use planning and management are essential for balanced urban development. Many European countries have a long-standing tradition in successfully integrating land-use planning with highly esthetical urban forms and economically sound solutions. United States, on the opposite, have a more loose approach to land-use planning and strategy, dominated by market driven forces. The Japanese approach to land-use, on the opposite, has shown how high economical interests can go hand in hand with maintaining good urban structures. (2- “Benchmark of Asian Public transport Interchanges”, UIC-Yellow design Foundation, 2011) In developing countries there is an evident need and interest in sustainable land-use solutions, as well as an awareness of the necessity of strategic planning, but institutional

capacities and political instabilities are typically the obstacles to actual implementation.

### 8.1 Function, Structure Type, Site Development Character, and Ownership.

In the perspective of a low-carbon stations for low carbon cities approach, land-use decisions and land-use plans are central to defying activities and functions fundamental to the attractiveness of stations, impacting transport mode choices, behaviour of travellers, and quality of public space and station architecture. Such choices therefore have direct and indirect consequences for climate, air quality, use of (renewable) energy, and accessibility to transport, economic development, and quality of life.

For many policy makers, government officials and commercial developers involved in mobility, land-use is a term mainly associated with real-estate values, control and regulations. However, the successful land-use approach does not have only the controlling and policing function: it establishes a good link between spatial planning, spatial design and instruments of control and legislation. The integration of these aspects of land-use form the core of more sustainable urban development practices.

- “Travel Demand and the Three Ds: Density, Diversity and Design” Cervero, R., and Kockelman, K., in *Transportation Research Part D: Transport and Environment* 2(2): 199-219., 1997 )



Matale - Sri Lanka

## 9. Low carbon land-use solutions in general.

According to the UN predictions (3- “World Population to 2030” , United Nations Department of Economic and Social Affairs/Population Division , New York, 2004) by 2050 almost two-thirds of the world population will live in metropolitan areas”, of these, “more than half will be urban dwellers”.In the light of these developments, cities have to (more than ever) try to satisfy a whole variety of basic human needs, such as housing, working, social life, leisure, and finally mobility - a function which connects all those needs. In order to create (and/ or preserve) liveable cities, the spatial requirements of all these functions need to be combined and balanced.

Urban planners around the world have acknowledged that land-use solutions driven by motorised, car-based urban transport are not a sustainable way of urban development. In Europe, Japan and only recently, North America, there is a rising awareness about the necessity to learn from the past. Low-density land-use patterns and complete functional segregation that accompany car-based monoculture have been characterised by Cervero R., and Kockelman K. as an important source of roadway congestion, energy depletion, air pollution and GHG emissions (4)



## 9.1 How and which land-use instruments can be deployed to change this?

There are several basic instruments that can be deployed on a general scale, according to GTZ and the most known among them are : According to (5 -“ Land-use Planning and Urban Transport”, GTZ, September 2004) there are several basic instruments that can be deployed on a general scale, the most known among them are:

- Mix of land-uses for various social and economic activities combined with high population densities. This approach minimises the distances between origins and destinations of urban trips, allowing sustainable modes of mobility (such as walking and cycling) to be developed.
- Influencing the spatial structure (spatial design) of the locations to stimulate less use of cars, and to reduce the length of urban trips.

As simple as it sounds, these basic principles are not always easy to implement, both in the developed and in the developing world. Decades of car-oriented policies, as well as perceived social status and market pressures in most countries worldwide still favour lcar oriented mobility, low-density and space consuming land-use decisions.

Another problem with framing the land-use solutions for low carbon cities is that most of the recommendations are based on different “density” approximations, whether that is urban population density, road density, or building density. These indicators are often not enough to explain the complexity of the space, the city and the human activities on the more immediate scale, since they are directed to more general policy-level

conclusions, as stated by Gornham (6) (1998) (6- “ Land-use Planning and Sustainable Urban Travel – Overcoming Barriers to Effective Co-ordination”, Gorham Roger, OECD-ECMT Workshop on land-use for Sustainable Urban Transport: Implementing Change, Linz Austria, 1998) these indicators are often not enough to explain the complexity of the space, the city, and human activities on the more immediate scale, since they are directed to more general policy-level conclusions.

Other, more context-dependent indicators related to land-use, such as the mix of functions within a block or an urban zone, the orientation of the buildings and of the city blocks, the street (network) patterns and street layout as well as various other urban design features can produce more relevant, context-aware low carbon solutions.



*Narvik, Norway*

## 10. Low carbon land-use solutions – for the station areas.

### 10.1 Transit Oriented Development (TOD) and (Transit Efficient Development (TED).

TOD (Transit Oriented Development (TOD) land-use theory and practice emerged as a reaction to the intense development of car-dependent, sprawled and mono-functional urban and suburban areas. In both the USA and Europe, the concept has been utilised as a starting point to discern public transport as a catalyst for revitalisation of urban neighbourhoods, an instrument that will bring new investments to the community, and enhance its sustainability through mixed use of spaces and neighbourhoods. The public transport station was re-discovered, and no longer seen as just a piece of infrastructure, but as an urban public space, a heterotopia, a vital focal point for the community and beyond.

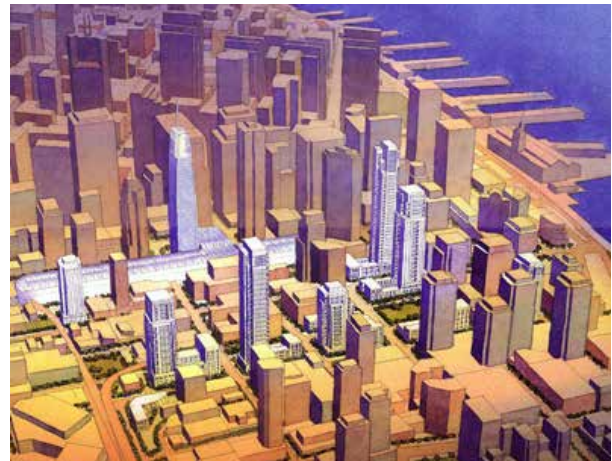

*San Francisco Bay Area TOD development \_ USA approach*

TOD uses integration of transportation in order to achieve a number of different objectives. “By facilitating more public transportation and more frequent use of public transportation, TOD can reduce dependence on fossil fuels, lower passenger transportation costs, promote walking and health, ease traffic congestion and improve environmental quality” (7- “Strategies and Tools to



High density TOD development USA approach

Implement Transportation-Efficient Development: A Reference Manual”). The same source, however, also points out that “thus far, many projects marketed as TODs are not fundamentally different from traditional residential suburban developments: they are not well-integrated within the station or the surrounding community, they include excessive parking, and they are neither mixed-use nor mixed-income.”

*An important TED indicator is the quality and density of development within 500 meters of transit stations. This distance is often used as a bottom line of walkability.*

TED (Transit Efficient Development (TED)) is another land-use approach, which places emphasis on discovering design and legislative solutions for improving the existing station environments. It can be defined along with transport efficiency.

TED and transport efficiency in general can be defined as “having a choice of easily accessible travel modes, lowering the need for Single-Occupant Vehicle (SOV) travel, and increasing opportunities for para-transit<sup>15</sup> and non-motorised travel” (Anne Vernez-Moudon 20000) (7-“Strategies and Tools to Implement Transportation-Efficient Development: A Reference Manual” Anne Vernez-Moudon.

Likewise this also implies more intensive use of existing infrastructure, redefinition of street profiles and public spaces. For stations and their (station) surroundings this pushes for more attention to managing the flows

between different modes and taking into account user patterns, their aspirations and their needs.



high density TOD development European approach - Stockholm central

<sup>15</sup> In the USA para-transit refers to the door-to-door service for disabled. In the rest of the world para-transit is a term often used to describe any door-to-door service that is not confined to fixed route of public transportation and is not formally regulated. It includes all the informal ways of (public) mobility, such as rickshaw's, tuc-tuc's, etc.



*[8b Opening of the Rotterdam Central in feb 2014 - more TED than TOD development*

## RECOMMENDATIONS

- create horizontal continuity in programme and land-use
- create direct, attractively landscaped routes
- create visual access to the public transport premises in the cityscape
- prominently communicate the presence of the public transport modes by announcing their proximity, the times of service etc, which will increase the interest in public transport.
- foster “mental access” to the PT modes (19-“Accessibility to train from information to station; a study based on a literature review and other references”, Schilling, R., KTH Division of Traffic and Transport Planning, Stockholm, Sweden, 1999)



*No barrier, access for all - new Rotterdam Central station plan  
- NS Spoorwegen – Dutch Railways*

## 10.2 Different land-use patterns for different travel modes.

Space requirements for different transport modes vary significantly, as illustrated by this famous photo. (12) This illustration shows very clearly how important it is to be aware of the “competition for space” between different travel modes in the city, which are essential for deciding which kind of mode (personal motorised, public transport, walking) will be supported and legalised by land-use plans.

The biggest competitor for space is the car. According to Gorham (6) “ One passenger car requires about 10 to 15 m<sup>2</sup> off the roadside. For parking lots, one has to calculate twice as much use of land space to account for access and exit. For a rough estimate of the accumulated land coverage, every car can be estimated to be associated with 1,5 parking places at various locations (home, office, shopping, etc) and two-thirds of these places can be assumed to be off-street. This leads to more than 3 km parking area requirements for an urban fleet of 100.000 cars”.

But, what do different land-use patterns mean for station areas, and how can they be optimised?

This table (11) summarises basic spatial requirements for various transport modes.

Mode	Capacity scenario (users/hour/lane*)	Speed (km/h)	Space demand (m <sup>2</sup> per user)
Pedestrian	25,500	4.7	0,7
Pedal Cycle +	5,400	12	8
Motorcycle ++	2,400	12	17,5
Car (Urban street)	1,050	12	40
Car (expressway)	3,000	40	47
Bus (55 seats)	7,700	10	4,5
Bus or Tram (150 seats)	18,000	10	2
Tram (250 seats)	24,000	10	1,5
Metro Rail	40,000	25	2,5

Table 11 - Space Requirement for various transport modes, under various operating conditions.\*

\* These figures are not maximum values or typical speeds for all situations, but rather present the space required under various conditions

\* The width of the lane is assumed as 3.4m

+ One user per pedal cycle

++ 1.1 users per motorcycle

All public transport modes are assumed to be 80% full.



Space requirements for different modes

## Pedestrians / Walking

The ease of reaching the interchange by walking is a basic indicator of accessibility, though often more attention is paid to the optimal functioning of motorised and rail-bound transportation systems than on how to access these systems walking.

Many stations have been conceived primarily as merely an element in the transport network, rather than an integral part of the urban environment. Consequently, local access routes are often neglected, leading to real and perceived inaccessibility of the interchange.

Walking as well as other non-motorised modes is a slow-speed movement. Connecting motorised and non-motorised modes of movement presents a challenge in designing an interchange station, because of their different speeds of movement and therefore different planning, design and safety requirements.

As stated in their research “Strategies and Tools to Implement Transportation-Efficient Development: A Reference Manual”, (7) the authors point out “that having a direct route available is more important for slower modes of travel (by default non-motorised modes), especially walking”. Walking as a travel mode is always present in the “mobility chain”, and therefore an important aspect not only in transitional spaces (corridors) but also in stationary/sedentary spaces such as parking lots. Poorly designed and badly located parking lots (long walking, several level changes, indirect connection routes) for non-motorised modes

(bikes, e-scooters, passengers drop-off zones) create barriers that hamper pedestrian accessibility and limit the use of the station and public transport in general.

The interconnection of different modes seems to have easy solutions, but its implementation involves complex details of accessibility, urban space management, and information integration. Interconnection with NMT (non-motorised mobility) is more difficult than with motorised transport as it requires different planning and design requirements.

In this context, it is important to develop an in-depth understanding of how PT infrastructure influences urban space, what are its negative triggers on land-use, and how they can be reduced.

## RECOMMENDATIONS

- Develop stations in such a way that each side is a port side.
- Avoid that access roads to the station (sometimes overloaded with public transport corridors, such as Bus Rapid Transit reserved lanes) and railway tracks (all combined) represent strong barriers that cut through urban space, leaving pockets of neglected lots behind. As such they cut off the neighbourhood from the remaining city dynamics and can, if no further action is taken, possibly become urban no-go zones. Stations that reveal this “barrier” effect are often perceived as an “interruption” rather than a cohesive factor.



*Biking in Ethiopia and China - different approaches to cycling integration*

## Cycling And Biking

Development of good bike lane access has been at the centre of many low carbon initiatives considering stations and station surroundings. Cycling and bike--and--ride facilities offer a number of environmental and societal benefits over the use of the private car. The environmental benefits include reduction in energy use, air and noise pollution (8 – “The bicycle as feeding mode: experiences from three European countries”, Karel Martens Transportation Research Part D: Transport and Environment, Volume 9, Issue 4, July 2004,) The benefits of the cycling also trigger health, and evidently also financial advantages, as shown in the “Mass Experiment 2012”, a research designed by Professor Niels Egelund, (9 – “Mass Experiment 2012”, Niels Egelund, Centre for Strategic Research in Education, Aarhus University Denmark, 2012) and carried out by researchers from Copenhagen and Aarhus Universities in collaboration with Research Center OPUS and Danish Science Communication. As a part of this trend, in several countries in Europe cycling to work is often encouraged through wage benefits.

Further on as stated in “The bicycle as a feeding mode: experiences from three European countries”: The magnitude of these (low--carbon and environmental) benefits will depend on the number and length of car trips that are being replaced by bike--and--ride. Even in case the bicycle only replaces feeding trips made by car, reductions in air pollution can be substantial given the high pollution levels related to cold starts. In addition to the environmental benefits, replacement of car trips by bike--and--ride could lower congestion levels on specific corridors or on access roads to stations, and could limit the need for bicycle parking lots adjacent to major train stations. Finally, bike--and--ride may strengthen the economic performance of specific types and lines of public transport, as it may attract an additional group of consumers. Taken together, these benefits make a strong case for bike--and--ride).



Medellin - Columbia

The same source (8) points out the following: “even in the context of a well--developed bicycle network (such as in the Netherlands), these networks do not always encompass bicycle lanes along main access roads to rail and bus stations.

Less attention has been paid to specific facilities that increase the attractiveness of the combined use of bicycle and public transport. Traditionally, train stations have been equipped with guarded bicycle parking, but lack of investment during the 1970s and 1980s resulted in problems regarding the quality, quantity and accessibility of many of these facilities”. Furthermore, “ Generally, bicycles were seen as competitors of buses, trams and metro lines. Bicycle parking facilities were usually only provided following an apparent demand in terms of parked bicycles at public transport stops. The lack of systematic attention is reflected in the number of bus, tram and metro stops that are equipped with bicycle parking facilities. Estimates show that 10–20% of all stops have dedicated parking facilities (8).

Fortunately, this disinvestment trend is gradually reversing, as railway operators start to consider cycling as part of the travel chain. Currently, major if not all railway operators in Europe invest in the development of well--lit, maintained and guarded bicycle parks, often accompanied with bike spare parts and repair shops.

## RECOMMENDATIONS

- Provide safe and efficient network of accessibility routes for different modes
- Create retail and service opportunity
- Encourage pedestrian and cycle feeder modes to interchange
- Set realistic KPIs in collaboration with the local community



## 10.3 Public space in station areas and land-use.

As cited in the research of Scott, F. (10-“InterchangeABLE: New design elements to reclaim the transport interchange”, Scott, F.Helen Hamlyn institute, UK, 2003) “Transport hubs are often situated in public spaces of low quality. Such spaces are busy and potentially vibrant, but too often they are desolate and characterless, failing to respond to their social and cultural context”.

If we want to position the station as a “heterotopia and community hub”, a place for the benefit and enrichment of the surrounding neighbourhood, we should first think of making it an accessible public space, with a strong local identity and recognisability. In the north as well as the global south, it should be a place for “creating opportunities”, through varied use of surrounding space and programming. Next to commuting, users should be able to find a certain service, job and education possibilities, to contribute to a local market, but also to be able to find space for meeting and leisure.

Depending on the local context, different strategies are needed to address this problem. In the context of the developing world, the difficulty lies in balancing land-use policies, existing social and cultural perceptions of public space and the urban commons, and urgency to develop sustainable urban mobility schemes within limited budgets. As the authors of the “Radical standard for the implementation of Spatial Justice in urban planning and design” (12) mention, the social dimension of mobility in the developing world is equally important as economically needed. In their research they also conclude that accessibility is the key to an ideal model of socially aware mobility planning: “Ownership of the car is not required to get home after an event, but it is essential that children can get to school or use public transport by themselves from an early age on. There is no need for humiliating walkways or delays in a public space when using a job centre or a social base. People who rely on public support because of their status (as migrants) must not be expected to accept higher levels of inconvenience to enjoy public benefits than the members of the local population.”

## RECOMMENDATIONS

- improve local identity of stations
- create interface (through land-use) between city, infrastructure and community
- increase the non-hardened green surfaces, as a measure for improving micro-climate, walking comfort as well as clearing / management of the run-off water.

## 10.4 Complex station structures and land-use.

Complex station structures, (where several different functional layers and different transportation modes are combined within one station yard) demand special land-use solutions. In this case we can speak of a “two-fold” land-use:

- a) land-use within the complex station (when complex station has more than just travel-service function, but combines also other functions, such as technical maintenance, commercial areas, parking lots, offices, etc). The crucial land-use issues within such a built entity are:
  - programmatic / functional diversity,
  - efficient stacking-up of the programme, and
  - sense of not losing the human scale due to infrastructural and operational demands of different means of transportation
- b) land-use of the surrounding areas, with special attention to:
  - surrounding block morphology
  - surrounding street network
  - stationary spaces, especially car-parking spaces
  - functional content of the surrounding blocks
  - environmental aspects of the surroundings

In theory (12 - “Nodes and Places: Complexities of Railway Station Redevelopment”, Bertolini, L, 1996), a “node-place” model provides an analytical framework to penetrate the dynamics of complex station area development. The underlying idea is that improving the transport (mobility) offer in a location, will, create conditions that favour further intensification and diversification of land-uses there.

But intensification and diversification can also put an extra pressure on the climate resilience of cities and its infrastructure. Station areas in the inner cities are traditionally dominated by hard surfaces and large buildings. But how can these features be transformed in such a way that they become more sustainable and resilient?

One of the approaches is to try to “reverse” the hard-surfaced land-uses and at least incorporate some of the more natural features. In their publication “Land and Water Management in the Urban Environment”, Dutch-based Deltares consultancy (13- “Land and water management in the urban areas”, Deltares, Delft, 2009) advise on the following:

“Use nature as an artery, at every scale level, from large city forest to green roof”. This can be especially applied to large hard surfaces of stations and infrastructure, from building envelope and rooftops, to station plaza’s en main public area’s connecting the station with the city.

## RECOMMENDATIONS

- Integrate the interchange with surrounding areas
- “make it a destination”
- create human scale within complex station structures, by using typologies such as “streetfront”, “market place” or “square” within the public areas of the stations.

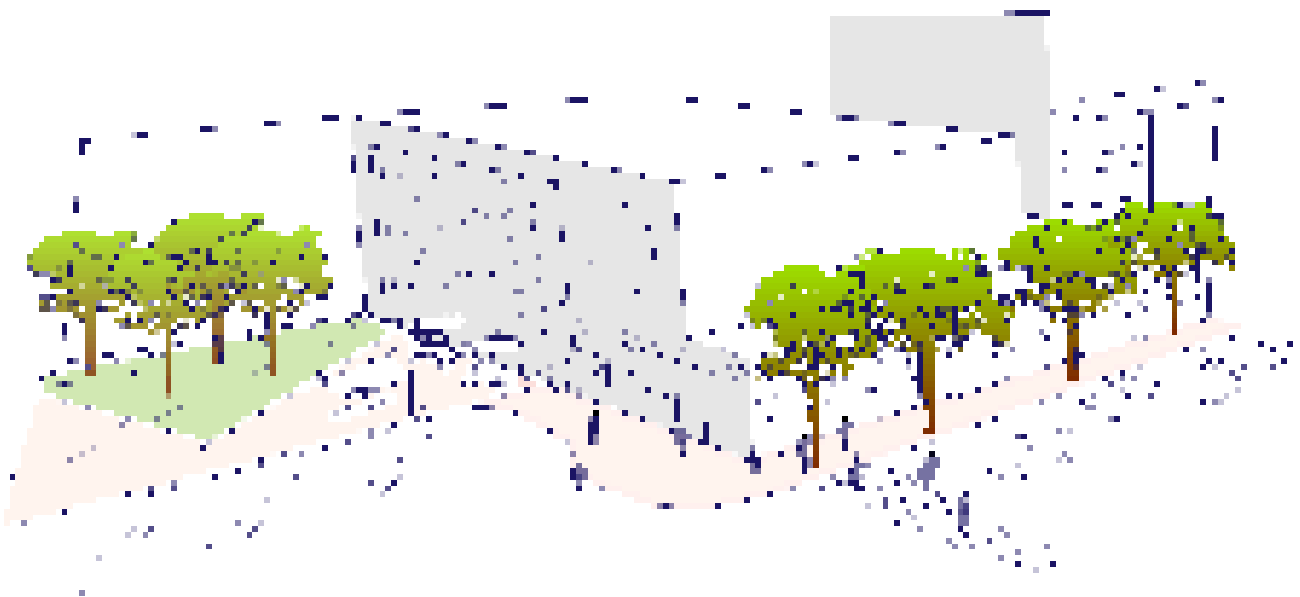

*Theoretical 3D model of the public space around interchange: continuous walkability without obstacles - (C) M. Ivkovic*

## 10.5 Pro's and con's of land-use strategies as a low carbon reduction instrument.

In most cases, land-use solutions and strategies require a long time to make an impact and become effective. The main reason for this is that urban form, once realised, is slow to change, and in case of stations (especially large station complexes) this presents an even bigger challenge, considering how difficult it is to reposition or adjust already laid-out infrastructure.

This fact contributes to the argument that effective transport policies (e. g. clean bus fleets) and better transport demand management (e.g subsidised public transport, higher car ownership taxes, higher parking fees) offer more and immediate GHG reductions.

To change land-use patterns on a large scale is indeed a slow and uncertain process. Still, many low carbon land-use strategies make a very good option when it comes to planning new stations and new neighbourhoods or settlements.. Also, small-scaled, neighbourhood-oriented land-use changes in the existing station and station surroundings can contribute to better quality of life, and therefore be valued as well. Legislative policies requiring more efficient appliances at the station, more efficient energy use and more cradle-to-cradle design principles can give positive effects on GHG reductions in the near and medium term.

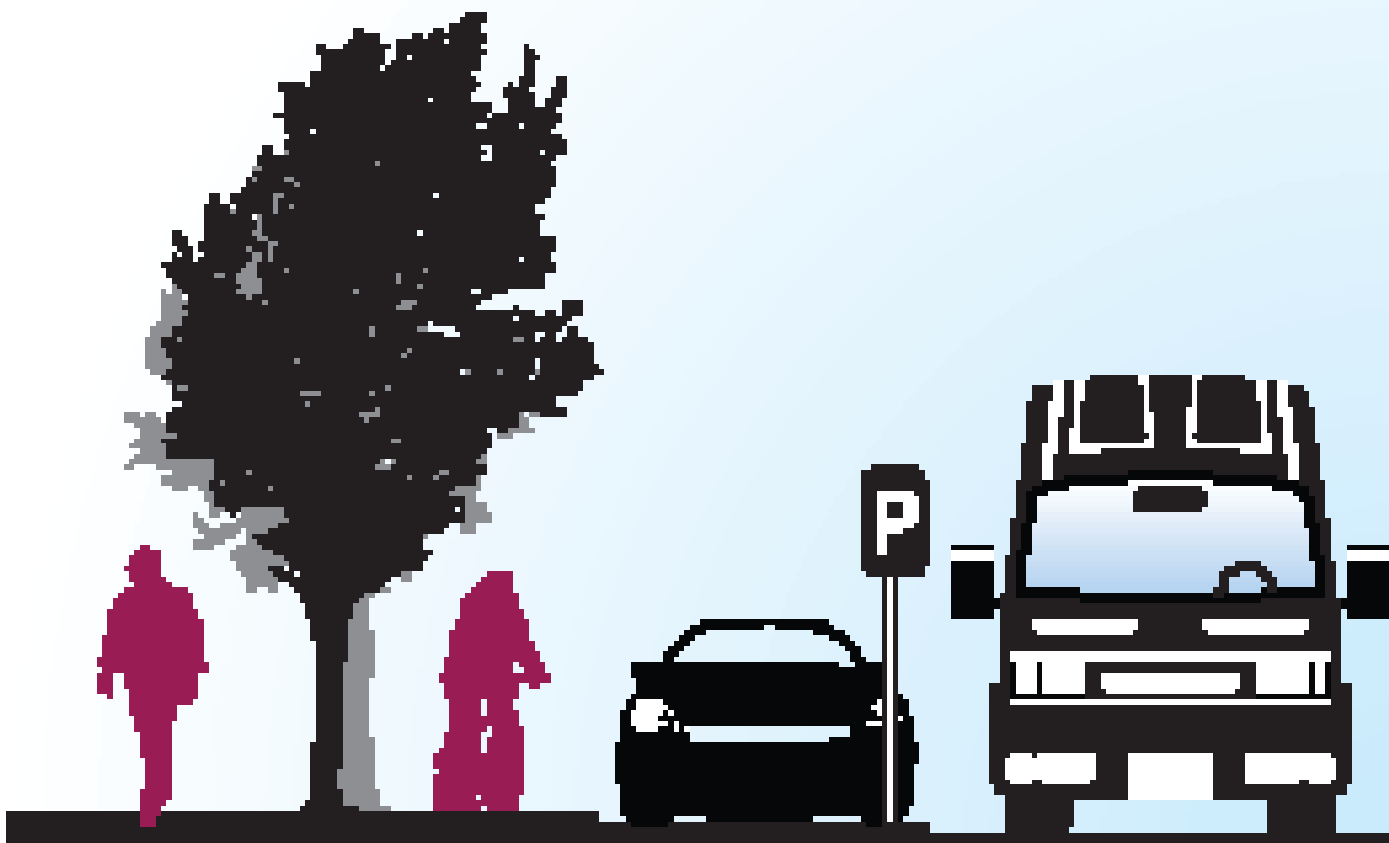

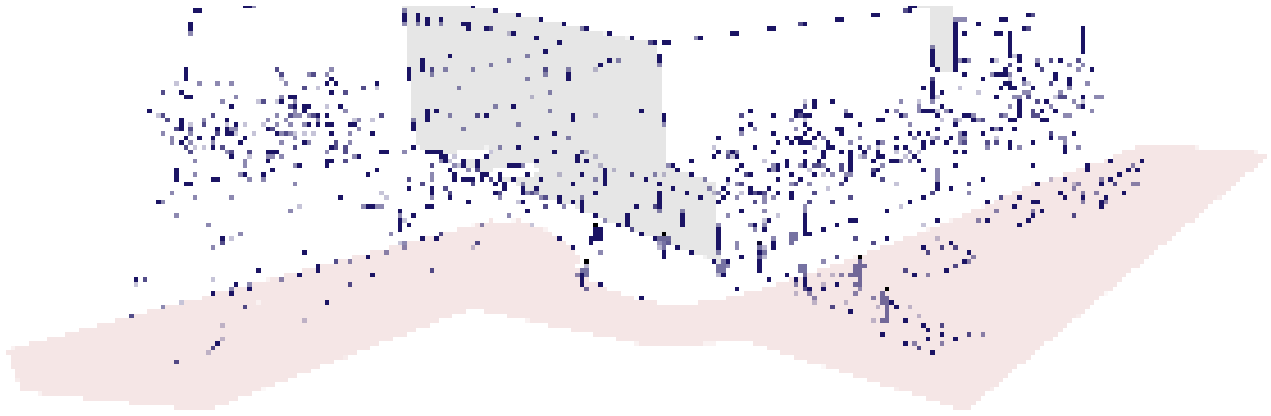

Theoretical 3D model of the public space around interchange:  
- clear separation from the motorized transport  
- activity and visual attractiveness on the street level around the station  
(C) M. Ivkovic

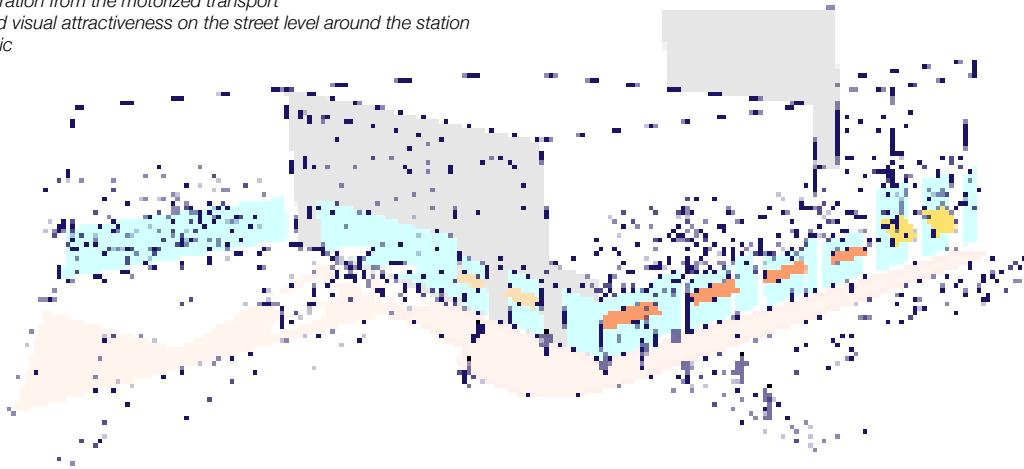

## References:

- 1) "Safer Homes, Stronger Communities: A Handbook for Reconstructing after Natural Disasters", chapter "Land-use and Physical Planning" published by the World Bank, January 2010
- 2) "Benchmark of Asian Public transport Interchanges", UIC-Yellow design Foundation, 2011
- 3) "World Population to 2300", United Nations Department of Economic and Social Affairs/ Population Division, New York, 2004
- 4) "Travel Demand and the Three Ds: Density, Diversity and Design" Cervero, R., and Kockelman, K., in *Transportation Research Part D: Transport and Environment* 2(2): 199-219., 1997
- 5) "Land-use Planning and Urban Transport", GTZ, September 2004
- 6) "Land-use Planning and Sustainable Urban Travel – Overcoming Barriers to Effective Co-ordination", Gorham Roger, OECD-ECMT Workshop on land-use for Sustainable Urban Transport: Implementing Change, Linz Austria, 1998
- 7) "Strategies and Tools to Implement Transportation-Efficient Development: A Reference Manual" Anne Vernez-Moudon, Professor, Matthew Cail, Nicolas Pergakes, Colin Forsyth, Lora Lillard, Research Assistants, Urban Form Lab, Department of Urban Design and Planning, University of Washington, Seattle, Washington and Washington State Transportation Center, September 2003
- 8) "The bicycle as feeding mode: experiences from three European countries", Karel Martens *Transportation Research Part D: Transport and Environment*, Volume 9, Issue 4, July 2004, Pages 281–294
- 9) "Mass Experiment 2012", Niels Egelund, Centre for Strategic Research in Education, Aarhus University Denmark, 2012
- 10) "InterchangeABLE: New design elements to reclaim the transport interchange", Scott, F.Helen Hamlyn institute, UK, 2003
- 11) "Radical standard for the implementation of Spatial Justice in urban planning and design" Johannes Fiedler, Melanie Humann, Manuela Kolke, Institut für Stadtebau – Technische Universität Braunschweig, 2012
- 12) "Nodes and Places: Complexities of Railway Station Redevelopment", Bertolini, L, 1996
- 13) "Land and water management in the urban areas", Deltares, Delft, 2009
- 14) "Land-use –Transport Interactions: Evidence from and Implications for Urban Public Transportation Systems", Christofer Zegras, Department of Urban Studies and Planning, MIT, 2013
- 15) *Meta Berghauser Pont, Per Haupt (2010) Spacematrix- Space Density and Urban Form*, , NAI Publishers, Rotterdam,
- 16) *NS Spoorwegen – Dutch Railways*
- 17) *Copenhagen*
- 18) *TranviaMurcia*
- 19) Schilling, R., KTH (1999) "Accessibility to train from information to station; a study based on a literature review and other references", Division of Traffic and Transport Planning, Stockholm, Sweden,



## Appendices

# Appendix A

## Establishing and tracking a carbon budget for a station or transport facility

### Introduction

There are currently no standards for the processes and procedures to establish and track carbon footprints for major infrastructure projects, though several are under development. It is expected that international standards will be forthcoming in the near future.

Nonetheless, simple amendments can be made to modify existing documents, procedures and internal institutions to establish a robust life cycle assessment for the carbon footprint of a station or transport facility.

This Appendix sets out the basic principles, provides some recommendations to amending contract documents and implementing a simple flow process. It is envisioned that the procedures outlined herein will be in line with recommendations forthcoming from the Paris COP 21 agreement in December 2015.

While the carbon emissions for standard materials are relatively well known and are being continually updated, there is little accurate embodied carbon emission data for electrical and mechanical equipment. A simple means of identifying the embodied carbon of for example a lift would be to weigh the lift, assume a breakdown by weight into steel, aluminium, glass etc. and calculate with the emissions values referred to above in the station design. It is questionable as to whether this is sufficiently accurate. An alternative method is provided below.

### A.1 Documentation

A number of contract documents are involved in the design, construction and operation of a station and transport line. Changes in these documents will be needed to:

- Underscore the importance of controlling carbon emissions;
- Detailing senior management's principles by implementing a life cycle assessment of carbon emissions;
- Define the carbon footprint in terms of the embodied and operational content;
- Provide direction and allocating responsibility for undertaking the necessary assessments during design, construction and operations;
- Approvals of targets and achievements and
- Certification of achievements in relation to payment.

This could involve the following:

- Design Standards Manual
  - Requiring a sufficient number of electricity meters such the power consumption of each major station operational element can be regularly monitored.
  - Stating that a carbon assessment shall be a part of the standard design process for the facility.
  - The manual could advise the standard of the carbon assessment or advise a specific procedure that shall be followed. If a standard table of carbon emission or procedure is not specified, then the manual shall state a requirement for the designer to propose that standard and procedure for approval by the employer (engineer).

- The life cycle carbon assessment shall include both the embodied carbon (that involved in the cradle to station) and the carbon emitted by the operations of the station. Typically emissions from operations are significantly larger than the embodied carbon content of the station<sup>1</sup>.
- Particular Specification for the Station:
  - Stating the initial carbon budget for the station, the percentage carbon reduction expected during the construction phase, and the payment conditions for achieving the contractual requirement.
  - Numbers and placement of the electricity meters
- Particular Specification of Electrical and Mechanical Equipment
  - A statement of the carbon footprint for each of the major electrical and mechanical pieces of plant for the station. This could be for an escalator, lift, cabling, air conditioner equipment, transformers etc.
  - Depending on resources available, the employer will need to decide the degree of auditing of the provided statements.

## A.2 Procedure for incorporating life cycle carbon assessment into a station delivery

The procedure is based on the establishment of a number of “check-points” where the life-cycle assessment can be established and modified based on the latest project design and details, also including reduction targets set by Senior Management (See Section A1 above). It is expected that the Project Director or their delegate would have the overall responsibility of delivering the project carbon emissions target.

The procedure is schematically represented in Figure A-1.

---

<sup>1</sup> Dr. Glenn Howard Frommer, Kit Fong Law, Chris CH Mak, Kenneth CH Chow, TOWARDS OPTIMISING CARBON EMISSIONS OF RAILWAYS The HKIE Civil Division International Conference 2012



The flowchart is based on a typical project roadmap and involves design, construction and operations. The life cycle process starts at the very beginning from the feasibility stage where alignments, transport modes, station numbers, sizes and types are used to evaluate the initial baseline carbon footprint. This evaluation will depend heavily on data gained from previous studies, such as embodied carbon per unit length of tunnels constructed by different methods, annual electricity consumption per square meter of station area, etc.

A life cycle carbon reduction target is then set by Senior Management, and carbon reduction elements are incorporated into subsequent project phases to achieve the overall project target. A review of the process will be undertaken after the Preliminary Design has been completed, seeking further carbon reduction opportunities in the Detailed Design phase.

As the project enters into construction, a series of monitoring and measurement elements would be launched to keep track of the changes and the actual execution of the design that may have an impact on the project carbon footprint. Design changes are common during both civil and E&M constructions, which would need to be logged, evaluated and reviewed against the set target. Actual use of material, in particular temporary construction works, may vary due to site conditions which differ from the detailed design and the accompanying assumptions. Again these data need to be logged to reflect the true carbon footprint of the project.

Once completed, the new station / system enters into service and electricity consumption data will be captured by the electricity meters. The energy use for the first full year of operation will be measured against the prediction made and its design target. An overall review of the process is proposed to update and enhance the assumptions used during different stages of the assessment.

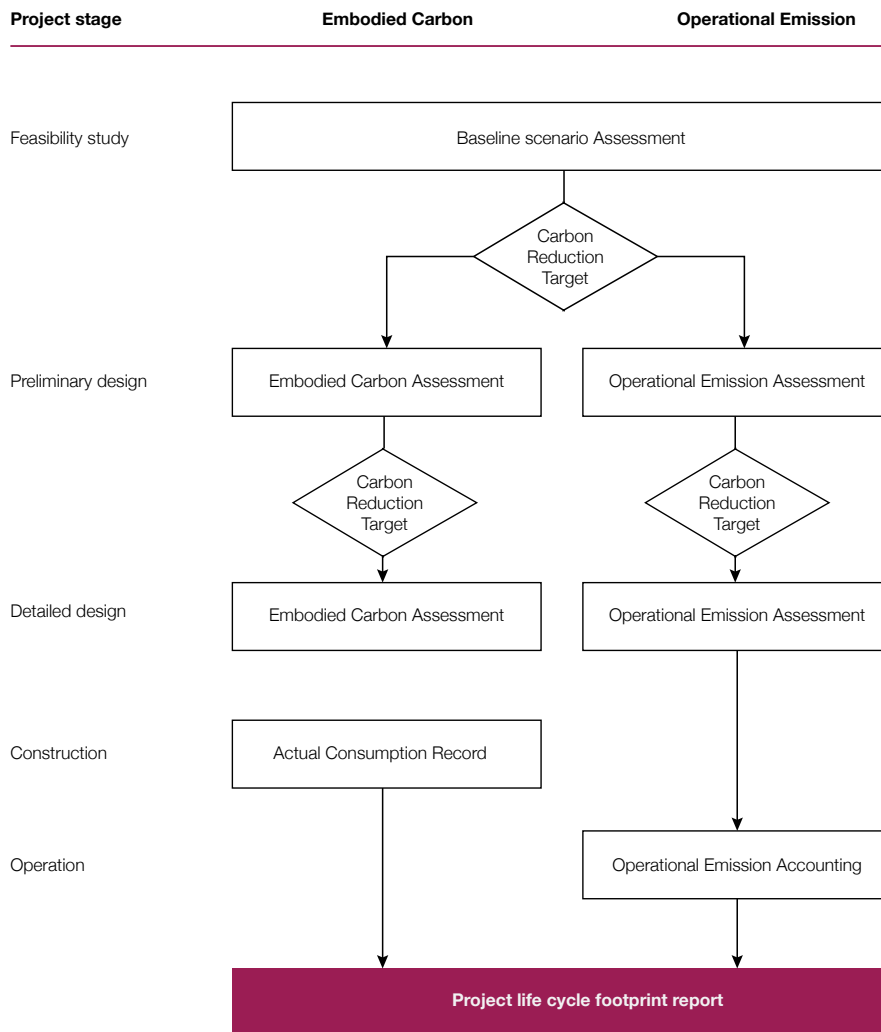

Figure A-1. Integrating Carbon Assessments into the Design Delivery Process.

# Appendix B

## Monitoring Progress

### B.1 Introduction

This study introduces a perspective for low-carbon station design and provides a large number of recommendations. As a complement to the study this Appendix details a framework to rationalise the chosen initiatives and provide a vehicle to track their achievement. The framework can also be depicted as a simple medallion providing a portrait to demonstrate the current status of achievement in reference to potential targets.

### B.2 Based on the British Standard

BS 8900:2006, the framework tracks maturity development of inclusivity, integrity, stewardship and transparency.

Depending on how the framework is used in conjunction with stakeholder engagement, the framework allows the proponent to:

- Embed their own culture;
- Create space for discussion and judgement;
- Include the impacts of everyday decisions;
- Make visible an audit trail of decision-making from strategy to front-line implementation.
- Focus resolving inherent tension and dilemmas; and
- Provide a common basis of information to assist in asking questions, testing potential responses and evaluating decisions.

### B.3 The framework

#### B.3.1 Principle and Practice

The framework principles are expanded through 10 practices. They are related as follows.

<b>Principle</b>	<b>Practice</b>
Inclusivity	Stakeholder engagement and issues identification
	Key drivers
Integrity	Leadership, vision and governance
	Managing risk
Stewardship	Sustainable development culture
	Building capability
	Key management issues, e.g. supply chain
Transparency	Environmental Assessment
	Review
	Reporting and building confidence

### B.3.1.2 Qualifying maturity (Refer to Figure B-1)

Each of the practices are characterized by a level of maturity ranging from Minimum involvement to Full engagement. Figure B-1 shows four levels each represented by a single column. Several achievement qualifiers are provided in each cell of Figure B-1. The recommendations included in this study for a low-carbon station development would need to be re-defined and documented for inclusion into the relevant qualifiers in this figure. This is typically undertaken in discussion with one or more stakeholders.

### B.3.1.3 Developing the maturity medallion

It is straightforward to assign numerical values when reviewing Figure B-1. To start assign a value of 1 to 4 to the four columns of the figure. Partial achievement of the qualifier in each cell would award a fractional result. For example when considering Integrity and managing risk, the project may have identified risks but not managed performance indicators or included sustainable development. In that case the maturity of the risk practice would be 2.3. Similarly when considering Stewardship and Building capability, the project may have achieved three of the four qualifiers and would be awarded 3.75.

Plotting the numerical attainment as a function of practice on a radar plot yields the unique medallion signifying achievement, Figure B-2. One can then use that picture in discussion to ascertain the acceptability of progress, management applicability, allocation of resources etc.

## Principles and practice

### Minimum involvement

Inclusivity	Stakeholder engagement and issues identification	Restricted to few	Defensive Some dialogue with immediate stakeholders, especially shareholders
Integrity	Key drivers	Quarterly returns-driven Profit paramount	Reactive-driven by regulatory, NGO, shareholder and/or investor pressures Cost/return decisions
	Leadership, vision and governance	Directive and narrowly focused	Adherence to (one or more) public codes
	Managing risk	Fire-fighting	Compliance by the book Compliance effort where likelihood of enforcement Seek "safe-harbours"
	Sustainable development culture	Minimalist: doing as little as can "get away with"	Tick-box approach, seeing PR only, if little cost/impact Meeting regulatory baseline requirements only
Stewardship	Building capability	Closed shop Minimum standards or below	Statutory rights only
	Key management issues, e.g. supply chain	Lowest price suppliers Latest possible payment	Supplier rating scheme based on technical compliance, cost and delivery time
	Environmental assessment	Minimal awareness Defensive posture	Standards not embraced Ad hoc solutions
	Review	Not valued	Minimal systems in place Conventional reporting
Transparency	Reporting and building confidence	Little or none unless pressed	Minimal or as required

## Characteristics of developing organizations

maturity	Full engagement
<p>Systematic stakeholder identification            Issues emerge and clarified            PR and competitive advantages recognized and opportunistically utilized</p>	<p>Strong and continuing engagement of all relevant stakeholders            Issues clear and regularly reviewed            Feedback networks established            Focus on strengthening relationships            Promotion and support of wider sustainable development</p>
<p>Sustainable development part of reputation/            risk management            Based on longer term development</p>	<p>Short, long term and broader view fully integrated            Proactive planning and seeking out opportunities            Championing of sustainable development</p>
<p>Leadership commitment consistent            Publish SD and SR statement, policy and objectives            Non Executives influential</p>	<p>Sustained leadership internally and externally            Purpose, vision and values integrated            Key role of reviews based on audit and analysis of performance</p>
<p>Main risks identified and managed            Performance indicators, but sustainable development separate</p>	<p>Sustainable development policies fully integrated            Spirit not letter            Prevention rather than cure</p>
<p>Seeing link between sustainable development and business advantage but PR/marketing focus            Developing education programme</p>	<p>Culture of sustainable development embedded at all levels            Values-led and ethical approach            Sustainable development part of all relevant planning and decision making            Wide understanding and buy-in            Sharing know-how outside organization</p>
<p>Building rights, responsibility frameworks and competencies            Stimulating innovation, learning and people-empowering</p>	<p>Continual reappraisal and learning            Recognizes and rewards sustainable actions            Encourages and values diversity            Internal cohesion and common direction</p>
<p>Broadened criteria of selection, to include SD, SR and environmental factors</p>	<p>Community of interest fully recognized            Assistance given to lower tiers where necessary</p>
<p>Education and training            Apply environmental policies and external standards</p>	<p>Environmental impact/risk assessments/audit comprehensive, integrated in decision making and valued            Prevention rather than cure</p>
<p>Analysis of needs            Integrated system design and planned dissemination</p>	<p>Periodic review and adjustment            All necessary recipients served</p>
<p>Selective to determined ends</p>	<p>Legitimate stakeholders (internal and external) receiving regular and appropriate reporting            Building understanding in the stakeholder community, seeking to explain decisions and implications, and wider long-term education beyond            Building trust and confidence</p>

# Maturity Matrix

## G Frommer 2007 - 2012

Principles and Practice		2007	2008	2009	2010	2011	2012
Inclusivity	Stakeholder engagement	3,7	3,5	3,6	3,6	3,6	
	Key drivers	3,6	3,6	3,6	3,6	3,6	
Integrity	Leadership, vision and governance	4	4	4	4	4	
	Managing risk	3,8	3,8	3,9	3,9	3,9	
Stewardship	Sustainable development culture	3,5	3,2	3,3	3,4	3,4	
	Building capability	3	3,3	3,5	3,6	3,6	
	Key mngmnt issues - supply chain	3,6	3,6	3,6	3,7	3,7	
	Environmental assessment	3,8	4	4	4	4	
Transparency	Review	4	4	4	4	4	
	Reporting - building confidence	4	3,8	3,8	3,8	3,8	

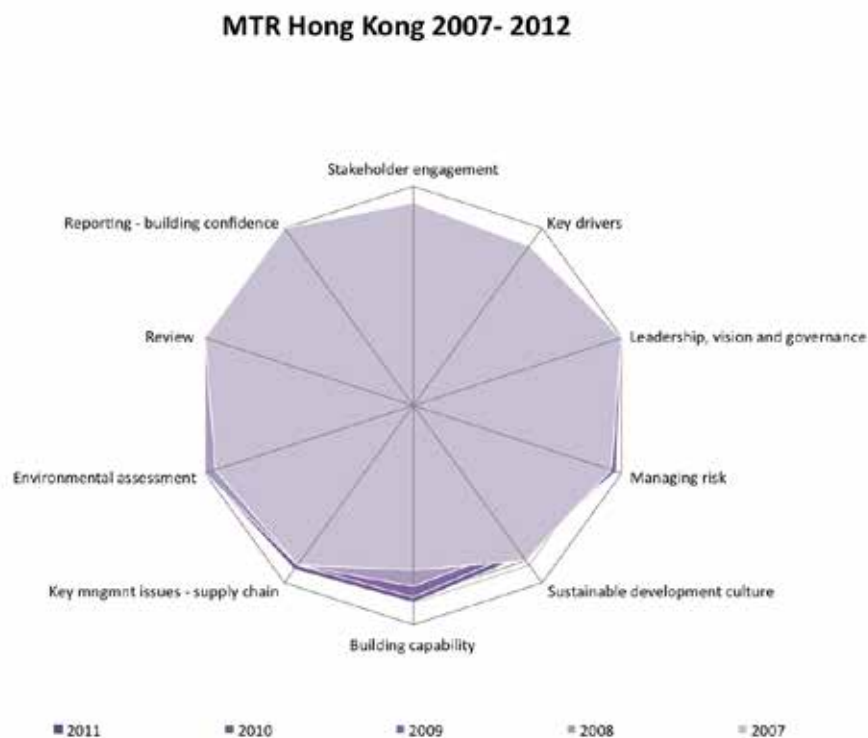

Figure B-1. An example of a Maturity Matrix

	Principles and Practice	Current achievement	Target
Inclusivity	Stakeholder engagement and issues identification	2,6	4
Integrity	Project Delivery	2,4	3
	Leadership, vision and governance	2,6	3,5
	Managing risk	2,6	3,7
Stewardship	Sustainable development Culture	2,4	3
	People Development	2,6	3,4
	Developing trusted partnerships	2,4	3
	Environmental management	3,4	3,5
Transparency	Review	3,4	4
	Reporting and building confidence	2,6	4

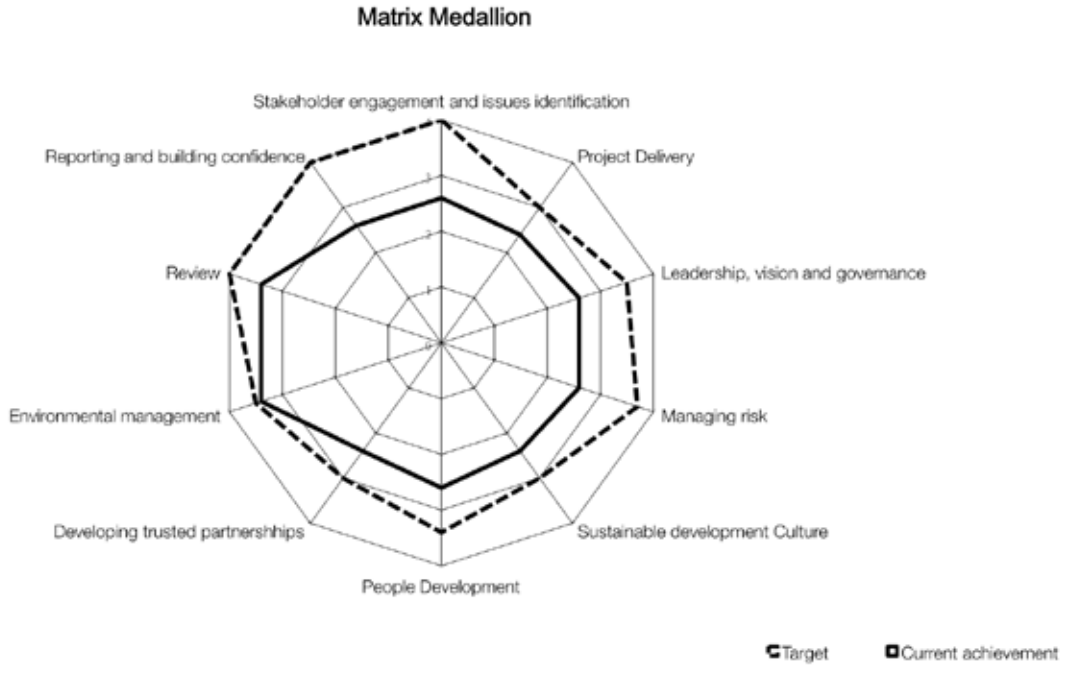

Figure B-2. An example of a Maturity Medallion

# Appendix C

## Smooth transition and short walking distances

Mainly for elderly, disabled or otherwise fragilised travellers, walking distances and level changes are a defining element in the decision process regarding the journey.

In the “Study on the foreign/Korean Railway Station Transfer System and Implications,” the relations between the quality of the interchange and the short walking distances are further analysed.

LOS Transfer time	The weighted average distance	
A	Within 1 min.	Under 60m
B	1-2 min	Under 60-120m
C	2-3 min.	Under 120-180m
D	3-4 min.	Under 180-240m
E	4-5min	Under 240-300m
F	Above 5 min.	Above 300m

\* walking velocity is assumed as 1.0m/sec

*Table 12- LOS or The Level of Service (A stands for highest level, F stands for lowest level) correlated to the transfer time getting into and out of the transport vehicle. Source “Study on the foreign/ Korean Railway Station Transfer System and Implications” (authors: Kim KwangMo, Park YongGul, Kim JinHo, Choi SungPil).*

- Ideal walking distances between entrance and platform do not exceed 10 min (150 m), taking into account the use of vertical communication. Ideal level changes do not exceed 2.
- Depending on the type of interchange according to the main organisation type (concentrated or vertical type, distribution or horizontal type and mixed type with both horizontal and vertical characteristics), some recommendations about the average transfer distance are defined. The recommendations can be seen in the following table 13.
- Table 13 – Preferred transfer distances between different transportation mode in an interchange
- Using escalators or other means of vertical communication slows down the passenger flow and the speed of walking (average walking speed for pedestrians is 1 m / sec, but when using stairs/escalators, it decreases to 0,6 m / sec), therefore the present table suggests shorter average transfer distances when different transportation modes are located on different levels.



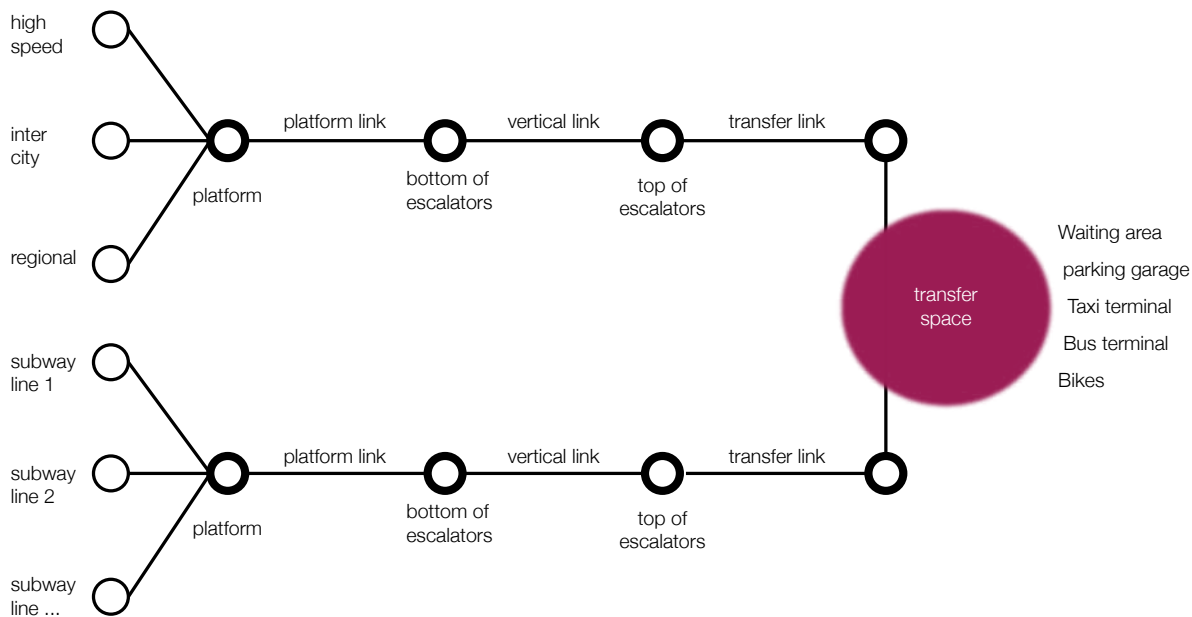

fig 35: Scheme of the inner network of the interchange

As shown on the fig 35, the inner network of the interchange is based on a series of links. The scheme proposes different levels between platforms/railway tracks and the transfer space. In other words, the track-based transportation (like metro and train) is separated from road-based motorized traffic. They are connected by the transfer space only.

- In order to segregate the flow of passengers, the transfer space at Beijing South and Shanghai Hongqiao is also a border line between paid and unpaid train service areas.

Alternative	Concentration Type(Vertical)		Distribution Type(Horizontal)	
	on foot	with escalator	on foot	with esc
Average Transfer Distance	133m	108m	250m	125m

(Source: UIC Asia Benchmark by Yellow design Foundation, 2011)

# Appendix D

## Carbon Capturing System (CCS)

CCS is a GHG emission reduction technology, whose deployment is dependent on an enabling policy framework. Given the substantial contribution CCS can potentially make in mitigating the risk of climate change, the quality of the policy matters. The International Energy Agency is engaged in analysing and developing options that policymakers can use for promoting safe and accountable CCS and for overcoming barriers to its deployment. This work includes national level CCS-specific policy and global climate policy development. (Source IEA, 2015)

According to the Carbon Capture and Storage Association, CCS can capture up to 90% of the carbon dioxide (CO<sub>2</sub>) emissions produced from the use of fossil fuels in electricity generation and industrial processes, preventing the carbon dioxide from entering the atmosphere. Furthermore, the use of CCS with renewable biomass is one of the few carbon abatement technologies that can be used in a 'carbon-negative' mode – actually taking carbon dioxide out of the atmosphere.

The CCS chain consists of three parts; capturing the carbon dioxide, transporting the carbon dioxide, and securely storing the carbon dioxide emissions, underground in depleted oil and gas fields or deep saline aquifer formations.

First, capturing technologies allow the separation of carbon dioxide from gases produced in electricity generation and industrial processes by one of three methods: pre-combustion capture, post-combustion capture and oxyfuel combustion.

Carbon dioxide is then transported by pipeline or by ship for safe storage. Millions of tonnes of carbon dioxide are already transported annually for commercial purposes by road tanker, ship and pipelines. The carbon dioxide is then stored in carefully selected geological rock formation that are typically located several kilometres below the earth's surface.

At every point in the CCS chain, from production to storage, industry has at its disposal a number

of process technologies that are well understood and have excellent health and safety records. The commercial deployment of CCS will involve the widespread adoption of these CCS techniques, combined with robust monitoring techniques and Government regulation. (Source: Carbon Capture System Association)

### Some fast facts:

- The International Energy Agency (IEA) estimates that energy demand could increase by as much as 45% by 2030. Much of this will be met by fossil fuels – for example, in the developing world, around two new coal-fired power stations are opened every week. CCS can decarbonise energy, generating low carbon power to help meet increasing energy demand.
- CCS is not only applicable to fossil fuel power plant, but can also be applied to any large industrial sources of carbon dioxide, such as cement, steel and chemical industries. In some sectors, CCS represents the sole option for reducing carbon dioxide emissions at the scale necessary.
- CCS combined with burning biomass for energy could result in negative carbon dioxide emissions. As plants grow, they absorb carbon dioxide from the atmosphere. If they are then burnt and the carbon dioxide captured and stored, there is a net reduction in carbon dioxide in the atmosphere.
- The Intergovernmental Panel on Climate Change (IPCC) found that to have a reasonable chance that global average temperature increases do not exceed pre-industrial levels by more than 2°C, then global carbon dioxide emissions must be reduced by between 50 – 85 % by 2050. To achieve this will require the application of all available low-carbon technologies at a scale and rate far greater than current efforts.

# Appendix E

## Customer Service Pledge

Line number or name		Target	Performance
Passenger journeys on time			
Train/bus service delivery			
Train/bus punctuality			
Train/bus reliability (engine car-km per train failure causing delays equal/ higher than 5 mins)			
Ticket reliability (magnetic ticket transactions per ticket failure)			
Ticket machine reliability			
Ticket gate reliability			
Passenger lift reliability			
Temperature and ventilation levels	• Trains		
	• Stations		
Station cleanliness	• Platforms		
	• Toilets		
Train/bus cleanliness	• Inside		
	• Outside		

**Yellow design Foundation**

39, Rue de l'Association - 1000 Bruxelles

Tel : +32(0)2 734 02 48 Email : [anne.leemans@ydesignfoundation.org](mailto:anne.leemans@ydesignfoundation.org) [www.ydesignfoundation.org](http://www.ydesignfoundation.org)

